

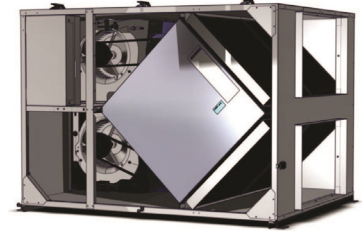

# MODEL TRC1600

(Energy Recovery Ventilators (ERV))



## Specifications

Ventilation Type: Static Plate, Heat and Humidity Transfer						
Typical Airflow Range: 500-2,025 CFM						
AHRI 1060 Certified Core: Two L125-00						
Airflow Rating Points (for AHRI): 1,500 CFM and 1,126 CFM						
Number Motors: Two belt drive blower/motor packages with adjustable sheaves						
Drive HP	V	Hz	Phase	FLA (per motor)	Min. Cir. Amps	Max. Overcurrent Protection Device
1.5	115	60	Single	15.2	34.2	45
	208-230	60	Single	8.2-7.6	18.5	25
	208-230	60	Three	4.6-4.8	10.8	15
	460	60	Three	2.4	5.4	15
Standard Features: Totally Enclosed Premium Efficiency Motors Motor Starters, Non-fused Disconnect 24 VAC Transformer/Relay Package						
Filters: Four total, MERV 8, 2" pleated, 20" x 20" nominal size						
Weight: 414 lbs (unit), 505 lbs (shipping weight, on pallet)						
Shipping Dimensions: 72" L x 48" W x 40" H						

## Airflow Performance

Motor HP	Blower RPM	Turns Open	External Static Pressure (in w.g.)													
			0.0		0.25		0.5		0.75		0.9		1.25		1.5	
			SCFM	BHP	SCFM	BHP	SCFM	BHP	SCFM	BHP	SCFM	BHP	SCFM	BHP	SCFM	BHP
1.5	1148	4	1592	0.7	1480	0.7	1320	0.6	1120	0.5	800	0.4	-	-	-	-
	1304	2	1809	1.0	1720	1.0	1600	0.9	1410	0.8	1250	0.7	975	0.6	630	0.4
	1460	0	2025	1.5	1950	1.4	1845	1.3	1715	1.2	1540	1.1	1400	1.0	1165	0.8

Note: Brake Horse Power (BHP) is for one blower motor package only.

## Performance

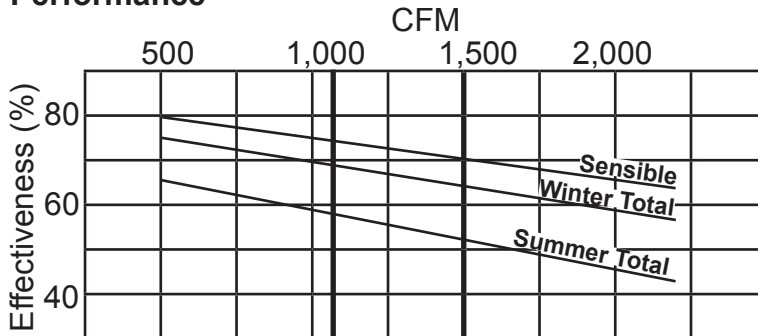

\* At AHRI 1060 standard conditions

For more information contact us at [www.solerpalau-usa.com](http://www.solerpalau-usa.com) or 1.800.961.7370 for additional submittal drawings. Soler & Palau will not be responsible for fabrication changes or errors resulting from customer use of a non-current submittal drawing.

Dimensions

# MODEL TRC1600

EA: Exhaust Air to outdoors  
 OA: Outdoor Air intake  
 RA: Room Air to be exhausted  
 FA: Fresh Air to inside

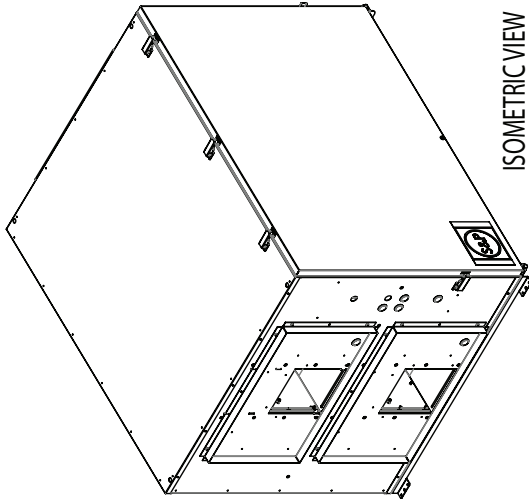

ISOMETRIC VIEW

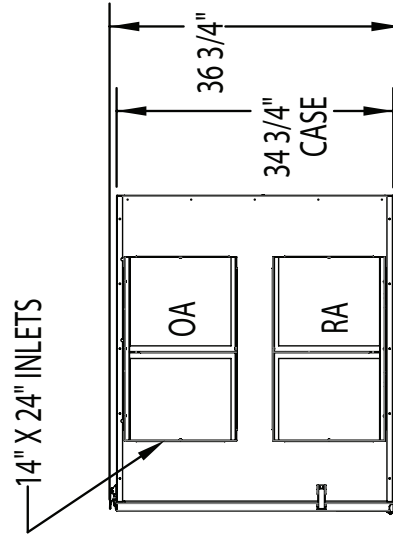

RIGHT VIEW

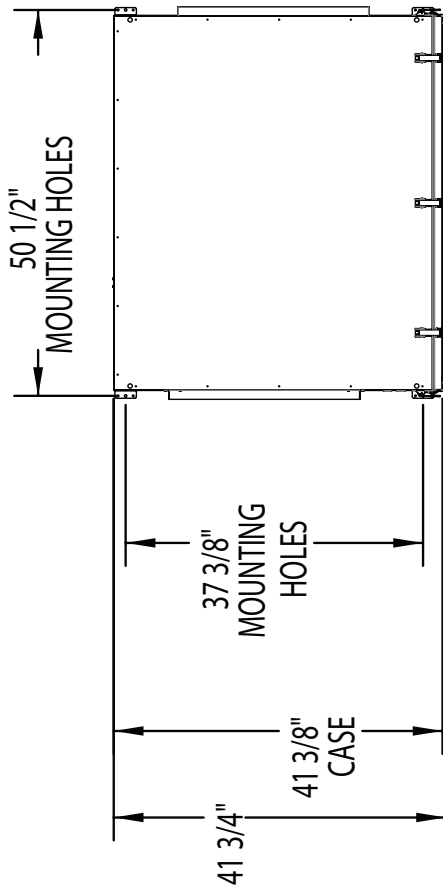

TOP VIEW

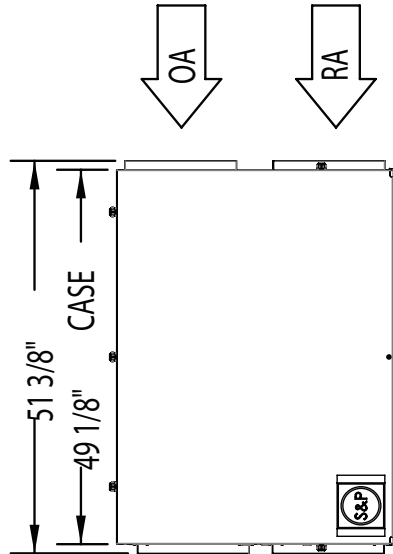

FRONT VIEW

Ø 7/8" CONTROL WIRING

Ø 7/8" POWER WIRING

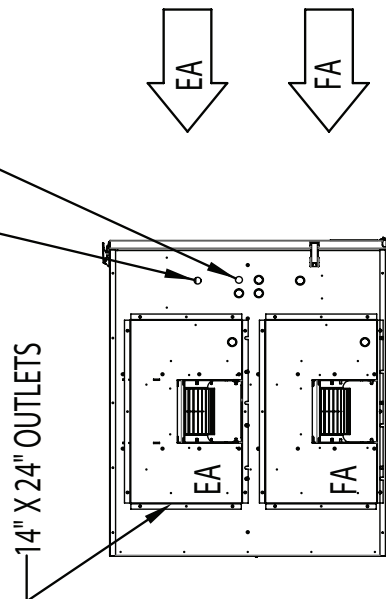

LEFT VIEW