

Z-Vent Single Wall

AL29-4C Gas Vent

Technical & Dimensional Data

Z-Vent single Wall AL29-4C Special Gas Vent



Contents

	Page No		Page No
Adapter Double Female	15	Flashing Steep Roof	15
Drain Pipe Vertical in-line	15	Guy Band	11
Drain Tee Horizontal	13	Storm Collar	10
Drain Tee Vertical	13	Support Base	12
		Support Firestop	11
Elbows 45 deg.	5	Support Vent	12
Elbows 90 Deg.	5	Wall Thimble	10
		Wall Thimble Extended	13
Pipe adjustable length	8		
Pipe lengths	3	Adaptors	
		Aerco	20
Rain Cap /w wind band	6	Ametek Fan	17
Rain Cap low resistance	6	Bosch	20
		Buderus GA 124/244	17
Reducers/Increasers	8	Burnham Triangle Tube	17
		Locking Band	17
Tee Caps	4	Modine	18
Tees	4	Noritz	20
Tees 45 Deg Lateral	7	Safety Vent	16
		Slant/Fin	18
Termination Box	7	Smith/Hydrotherm	18
Termination Coupling	14	Starite	19
Termination Elbow	14	Universal	15
Termination Hood	14	Utica	19
Termination Tee	13	Viessmann	19
		WM CGI	16
Accessories		WM GV Starter 2	16
Flashing Adjustable	9	WM Starter Tee 3/4	16
Flashing Flat	9		

Z-Vent single Wall AL29-4C Special Gas Vent



Pipe

Available in diameters 3in to 24in and standard lengths up to 10ft (3in and 4in diameter only). Pipe can be cut to length. The female end of each Z-Vent component incorporates a silicone sealing gasket. Examine all components to ensure that gasket integrity has remained during shipping. Gaskets must be in proper position or flue gases could leak resulting in carbon monoxide poisoning. The installation shall be in accordance with the manufacturer's installation instructions.

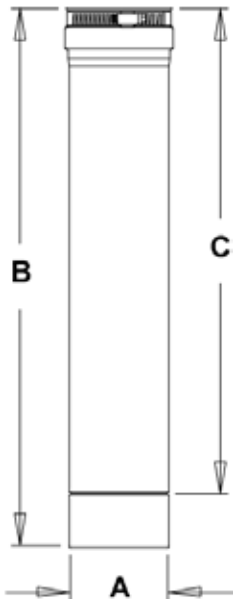

A	B	C	Part Number	Description
3in	6	4	2SVEPWC03.5	Z-Vent Pipe 3in x 6in
	12	10	2SVEPWC0301	Z-Vent Pipe 3in x 1 ft
	18	16	2SVEPWC0301.5	Z-Vent Pipe 3in x 1.5ft
	24	22	2SVEPWC0302	Z-Vent Pipe 3in x 2ft
	36	34	2SVEPWC0303	Z-Vent Pipe 3in x 3ft
	48	46	2SVEPWC0304	Z-Vent Pipe 3in x 4ft
	60	58	2SVEPWC0306	Z-Vent Pipe 3in x 5ft
	96	94	2SVEPWC0308	Z-Vent Pipe 3in x 8ft
	120	118	2SVEPWC0310	Z-Vent Pipe 3in x 10ft
	4in	6	4	2SVEPWC04.5
12		10	2SVEPWC0401	Z-Vent Pipe 4in x 1 ft
18		16	2SVEPWC0401.5	Z-Vent Pipe 4in x 1.5ft
24		22	2SVEPWC0402	Z-Vent Pipe 4in x 2ft
36		34	2SVEPWC0403	Z-Vent Pipe 4in x 3ft
48		46	2SVEPWC0404	Z-Vent Pipe 4in x 4ft
60		58	2SVEPWC0405	Z-Vent Pipe 4in x 5ft
96		94	2SVEPWC0408	Z-Vent Pipe 4in x 8ft
120		118	2SVEPWC0410	Z-Vent Pipe 4in x 10ft
5in		6	4	2SVEPWC05.5
	12	10	2SVEPWC0501	Z-Vent Pipe 5in x 1 ft
	18	16	2SVEPWC0501.5	Z-Vent Pipe 5in x 1.5ft
	24	22	2SVEPWC0502	Z-Vent Pipe 5in x 2ft
	36	34	2SVEPWC0503	Z-Vent Pipe 5in x 3ft
	48	46	2SVEPWC0504	Z-Vent Pipe 5in x 4ft
6in	6	4	2SVEP06.5	Z-Vent Pipe 6in x 6in
	12	10	2SVEP0601	Z-Vent Pipe 6in x 1 ft
	18	16	2SVEP0601.5	Z-Vent Pipe 6in x 1.5ft
	24	22	2SVEP0602	Z-Vent Pipe 6in x 2ft
	36	34	2SVEP0603	Z-Vent Pipe 6in x 3ft
7in	6	4	2SVEP07.5	Z-Vent Pipe 7in x 6in
	12	10	2SVEP0701	Z-Vent Pipe 7in x 1 ft
	18	16	2SVEP0701.5	Z-Vent Pipe 7in x 1.5ft
	24	22	2SVEP0702	Z-Vent Pipe 7in x 2ft
	36	34	2SVEP0703	Z-Vent Pipe 7in x 3ft
8in	6	4	2SVEP8.5	Z-Vent Pipe 8in x 6in
	12	10	2SVEP801	Z-Vent Pipe 8in x 1 ft
	18	16	2SVEP801.5	Z-Vent Pipe 8in x 1.5ft
	24	22	2SVEP802	Z-Vent Pipe 8in x 2ft
	36	34	2SVEP803	Z-Vent Pipe 8in x 3ft
48	46	2SVEP804	Z-Vent Pipe 8in x 4ft	

A	B	C	Part Number	Description
10in	6	4	2SVEP10.5	Z-Vent Pipe 10in x 6in
	12	10	2SVEP1001	Z-Vent Pipe 10in x 1 ft
	18	16	2SVEP1001.5	Z-Vent Pipe 10in x 1.5ft
	24	22	2SVEP1002	Z-Vent Pipe 10in x 2ft
	36	34	2SVEP1003	Z-Vent Pipe 10in x 3ft
	12in	6	4	2SVEP12.5
12		10	2SVEP1201	Z-Vent Pipe 12in x 1 ft
18		16	2SVEP1201.5	Z-Vent Pipe 12in x 1.5ft
24		22	2SVEP1202	Z-Vent Pipe 12in x 2ft
36		34	2SVEP1203	Z-Vent Pipe 12in x 3ft
14in		6	4	2SVEP14.5
	12	10	2SVEP1401	Z-Vent Pipe 14in x 1 ft
	18	16	2SVEP1401.5	Z-Vent Pipe 14in x 1.5ft
	24	22	2SVEP1402	Z-Vent Pipe 14in x 2ft
	36	34	2SVEP1403	Z-Vent Pipe 14in x 3ft
	16in	6	4	2SVEP16.5
12		10	2SVEP1601	Z-Vent Pipe 16in x 1 ft
18		16	2SVEP1601.5	Z-Vent Pipe 16in x 1.5ft
24		22	2SVEP1602	Z-Vent Pipe 16in x 2ft
36		34	2SVEP1603	Z-Vent Pipe 16in x 3ft
18in		6	4	2SVEP18.5
	12	10	2SVEP1801	Z-Vent Pipe 18in x 1 ft
	18	16	2SVEP1801.5	Z-Vent Pipe 18in x 1.5ft
	24	22	2SVEP1802	Z-Vent Pipe 18in x 2ft
	36	34	2SVEP1803	Z-Vent Pipe 18in x 3ft
	20in	6	4	2SVEP20.5
12		10	2SVEP2001	Z-Vent Pipe 20in x 1 ft
18		16	2SVEP2001.5	Z-Vent Pipe 20in x 1.5ft
24		22	2SVEP2002	Z-Vent Pipe 20in x 2ft
36		34	2SVEP2003	Z-Vent Pipe 20in x 3ft
22in		6	4	2SVEP22.5
	12	10	2SVEP2201	Z-Vent Pipe 22in x 1 ft
	18	16	2SVEP2201.5	Z-Vent Pipe 22in x 1.5ft
	24	22	2SVEP2202	Z-Vent Pipe 22in x 2ft
	36	34	2SVEP2203	Z-Vent Pipe 22in x 3ft
	24in	6	4	2SVEP24.5
12		10	2SVEP2401	Z-Vent Pipe 24in x 1 ft
18		16	2SVEP2401.5	Z-Vent Pipe 24in x 1.5ft
24		22	2SVEP2402	Z-Vent Pipe 24in x 2ft
36	34	2SVEP2403	Z-Vent Pipe 24in x 3ft	

Z-Vent single Wall AL29-4C Special Gas Vent



Tees

A tee is used to connect horizontal and vertical vent sections

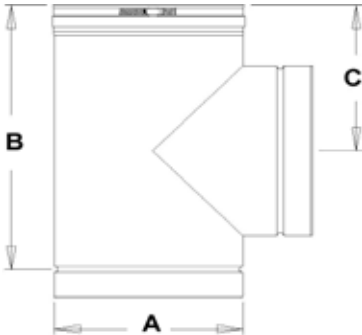

A	B	C	Part Number	Description
5	10.5	6.5	2SVST05	Z-Vent Tee 5in
6	10.5	6.5	2SVST06	Z-Vent Tee 6in
7	12.5	7.5	2SVST07	Z-Vent Tee 7in
8	14.5	8.5	2SVST08	Z-Vent Tee 8in
10	18.5	10.5	2SVST10	Z-Vent Tee 10in
12	20.5	10.5	2SVST12	Z-Vent Tee 12in
14	22.5	12.5	2SVST14	Z-Vent Tee 14in
16	24.5	13.5	2SVST16	Z-Vent Tee 16in
18	26.5	14.5	2SVST18	Z-Vent Tee 18in
20	28.5	15.5	2SVST20	Z-Vent Tee 20in
22	30.5	16.5	2SVST22	Z-Vent Tee 22in
24	32.5	17.5	2SVST24	Z-Vent Tee 24in

Tee Cap with Drain

A tee cap with drain is required at the bottom of a vertical stack. High temperature silicone tubing is available separately.

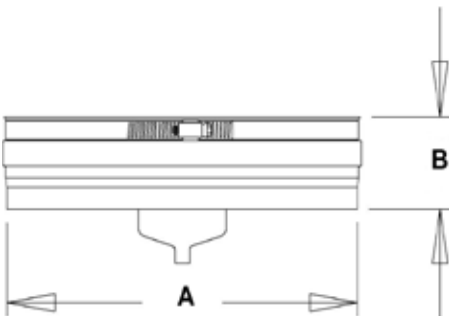

A	B	Part Number	Description
4	3	2SVSTCD04	Z-Vent Tee Cap 4in
5	3	2SVSTCD05	Z-Vent Tee Cap 5in
6	3	2SVSTCD06	Z-Vent Tee Cap 6in
7	3	2SVSTCD07	Z-Vent Tee Cap 7in
8	3	2SVSTCD08	Z-Vent Tee Cap 8in
10	3	2SVSTCD10	Z-Vent Tee Cap 10in
12	3	2SVSTCD12	Z-Vent Tee Cap 12in
14	3	2SVSTCD14	Z-Vent Tee Cap 14in
16	3	2SVSTCD16	Z-Vent Tee Cap 16in
18	3	2SVSTCD18	Z-Vent Tee Cap 18in
20	3	2SVSTCD20	Z-Vent Tee Cap 20in
22	3	2SVSTCD22	Z-Vent Tee Cap 22in
24	3	2SVSTCD24	Z-Vent Tee Cap 24in

Z-Vent single Wall AL29-4C Special Gas Vent



45° Elbows

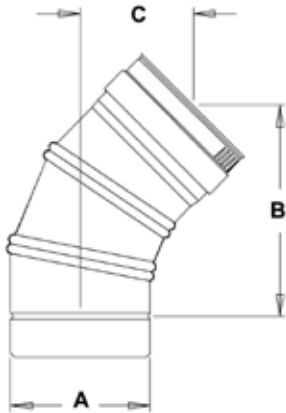

45° elbows are used when a direction change or offset is required.

A	B	C	Part Number	Description
3	3.5	2.25	2SVEEWCF0345	Z-Vent Elbow 45° x 3in
4	4	2.50	2SVEEWCF0445	Z-Vent Elbow 45° x 4in
5	4.5	2.50	2SVEEWC0545	Z-Vent Elbow 45° x 5in
6	4.75	2.75	2SVEE0645	Z-Vent Elbow 45° x 6in
7	5	4	2SVEE0745	Z-Vent Elbow 45° x 7in
8	5.5	4	2SVEE0845	Z-Vent Elbow 45° x 8in
10	6	4	2SVEE1045	Z-Vent Elbow 45° x 10in
12	6.5	4.50	2SVEE1245	Z-Vent Elbow 45° x 12in
14	7	4.50	2SVEE1445	Z-Vent Elbow 45° x 14in
16	7.75	5	2SVEE1645	Z-Vent Elbow 45° x 16in
18	9	6	2SVEE1845	Z-Vent Elbow 45° x 18in
20	10	6.50	2SVEE2045	Z-Vent Elbow 45° x 20in
22	11	7	2SVEE2245	Z-Vent Elbow 45° x 22in
24	12	7.50	2SVEE2445	Z-Vent Elbow 45° x 24in

90° Elbows

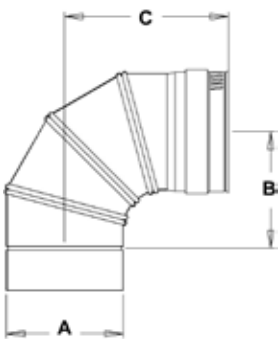

90° elbows are used when a direction change or offset is required.

A	B	C	Part Number	Description
3	3.75	5.75	2SVEEWCF0390	Z-Vent Elbow 90° x 3in
4	4.25	6.25	2SVEEWCF0490	Z-Vent Elbow 90° x 4in
5	4.5	6.75	2SVEEWC0590	Z-Vent Elbow 90° x 5in
6	5.25	7.25	2SVEE0690	Z-Vent Elbow 90° x 6in
7	6	7.5	2SVEE0790	Z-Vent Elbow 90° x 7in
8	7	8	2SVEE0890	Z-Vent Elbow 90° x 8in
10	7.75	9.75	2SVEE1090	Z-Vent Elbow 90° x 10in
12	9.25	10.50	2SVEE1290	Z-Vent Elbow 90° x 12in
14	9.5	11.25	2SVEE1490	Z-Vent Elbow 90° x 14in
16	10.75	12.75	2SVEE1690	Z-Vent Elbow 90° x 16in
18	11.50	13.50	2SVEE1890	Z-Vent Elbow 90° x 18in
20	12.25	14.75	2SVEE2090	Z-Vent Elbow 90° x 20in
22	13	15.25	2SVEE2290	Z-Vent Elbow 90° x 22in
24	14	16	2SVEE2490	Z-Vent Elbow 90° x 24in

Z-Vent single Wall AL29-4C Special Gas Vent



Low Resistance Rain Cap

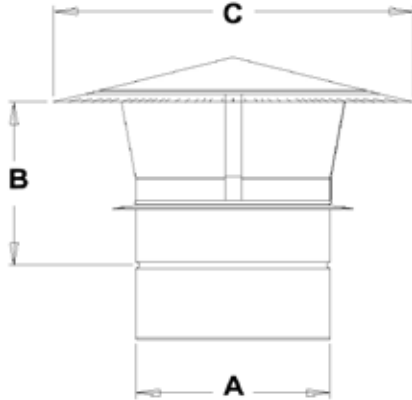

A low resistance rain cap is designed to terminate a vertical stack and prevent the entrance of debris or rain into the vent. It also provides low resistance to flue gas flow.

A	B	C	Part Number	Description
5	5	10	2SVSRC05	Low Resistance Rain Cap 5in
6	5.5	11	2SVSRC06	Low Resistance Rain Cap 6in
7	6.5	13	2SVSRC07	Low Resistance Rain Cap 7in
8	7.25	15	2SVSRC08	Low Resistance Rain Cap 8in
10	9	18	2SVSRC10	Low Resistance Rain Cap 10in
12	11	22	2SVSRC12	Low Resistance Rain Cap 12in
14	12.75	26	2SVSRC14	Low Resistance Rain Cap 14in
16	14.5	30	2SVSRC16	Low Resistance Rain Cap 16in
18	16.5	34	2SVSRC18	Low Resistance Rain Cap 18in
20	18.25	38	2SVSRC20	Low Resistance Rain Cap 20in
22	20	41	2SVSRC22	Low Resistance Rain Cap 22in
24	22	45	2SVSRC24	Low Resistance Rain Cap 24in

Rain Cap

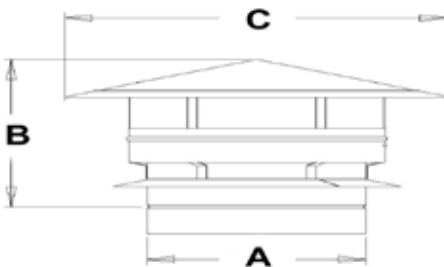

A rain cap is designed to terminate a vertical stack and prevent the entrance of debris or rain into the vent. Includes wind band to prevent draft loss.

A	B	C	Part Number	Description
3	6	9	2SVSRCF03	Rain cap /w wind band 3in
4	6	9	2SVSRCF04	Rain cap /w wind band 4in
5	6.5	11.5	2SVSRXC05	Rain cap /w wind band 5in
6	6.5	13	2SVSRXC06	Rain cap /w wind band 6in
7	6.5	13	2SVSRXC07	Rain cap /w wind band 7in
8	6.5	13	2SVSRXC08	Rain cap /w wind band 8in
9	6.5	15	2SVSRXC09	Rain cap /w wind band 9in
10	8	13	2SVSRXC10	Rain cap /w wind band 10in
12	8	15	2SVSRXC12	Rain cap /w wind band 12in
14	8	15	2SVSRXC14	Rain cap /w wind band 14in
16	12	20	2SVSRXC16	Rain cap /w wind band 16in
18	12	23	2SVSRXC18	Rain cap /w wind band 18in
20	12	26	2SVSRXC20	Rain cap /w wind band 20in
22	12	29	2SVSRXC22	Rain cap /w wind band 22in
24	12	32	2SVSRXC24	Rain cap /w wind band 24in

Z-Vent single Wall AL29-4C Special Gas Vent



Lateral 45°

A lateral 45° is designed to allow a low flow resistance connection of horizontal and vertical sections. A tee cap is available separately.

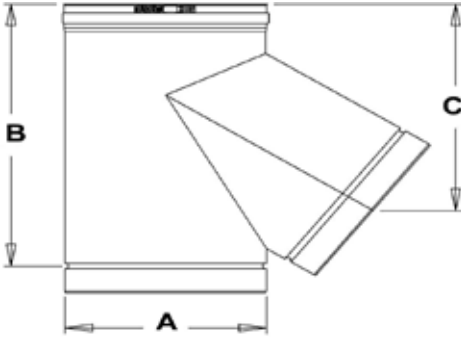

A	B	C	Part Number	Description
5	13	12	2SVSL0545	Z-Vent Lateral 45° x 5in Tee
6	14	13	2SVSL0645	Z-Vent Lateral 45° x 6in Tee
7	15.5	14.5	2SVSL0745	Z-Vent Lateral 45° x 7in Tee
8	17	15	2SVSL0845	Z-Vent Lateral 45° x 8in Tee
10	20	17.5	2SVSL1045	Z-Vent Lateral 45° x 10in Tee
12	23	19.5	2SVSL1245	Z-Vent Lateral 45° x 12in Tee
14	26	21.5	2SVSL1445	Z-Vent Lateral 45° x 14in Tee
16	28.5	24	2SVSL1645	Z-Vent Lateral 45° x 16in Tee
18	31.5	26	2SVSL1845	Z-Vent Lateral 45° x 18in Tee
20	34.25	28	2SVSL2045	Z-Vent Lateral 45° x 20in Tee
22	37	30	2SVSL2245	Z-Vent Lateral 45° x 22in Tee
24	40	32.25	2SVSL2445	Z-Vent Lateral 45° x 24in Tee

Wall Termination

A wall termination is used to terminate a horizontal vent. The special design resists winds from affecting flue gas flow.

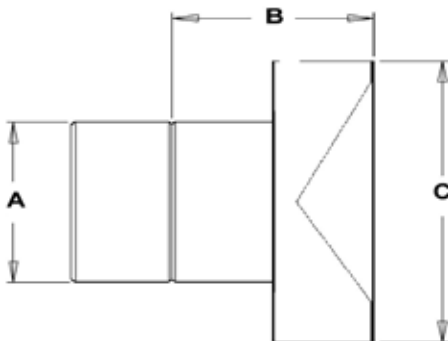

A	B	C	Part Number	Description
3	4	5	2SVSRTF03	Termination Box 3in
4	4	6	2SVSRTF04	Termination Box 4in
5	4.125	7	2SVSRTX05	Termination Box 5in
6	4.75	8	2SVSRTX06	Termination Box 6in
7	5.25	9	2SVSRTX07	Termination Box 7in
8	5.75	10	2SVSRTX08	Termination Box 8in
10	7	12	2SVSRTX10	Termination Box 10in
12	8	14	2SVSRTX12	Termination Box 12in
14	9	16	2SVSRTX14	Termination Box 14in
16	10	18	2SVSRTX16	Termination Box 16in
18	11	20	2SVSRTX18	Termination Box 18in
20	12	22	2SVSRTX20	Termination Box 20in
22	13	24	2SVSRTX22	Termination Box 22in
24	14	28	2SVSRTX24	Termination Box 24in

Z-Vent single Wall AL29-4C Special Gas Vent



Increaser

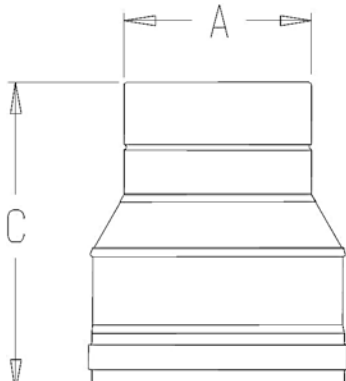

Used to upsize a vent system

A	B	C	Part Number	Description
3	4,5,6	10	2SVSIO(A)O(B)	Z-Vent Increaser(A)to(B)
4	5,6,7	10	2SVSIO(A)O(B)	Z-Vent Increaser(A)to(B)
5	6,7,8	10	2SVSIO(A)O(B)	Z-Vent Increaser(A)to(B)
6	7,8,10	10	2SVSIO(A)O(B)	Z-Vent Increaser(A)to(B)
7	8,10,12	10	2SVSIO(A)O(B)	Z-Vent Increaser(A)to(B)
8	10,12	10	2SVSIO(A)O(B)	Z-Vent Increaser(A)to(B)
10	12	10	2SVSIO(A)O(B)	Z-Vent Increaser(A)to(B)

Reducer

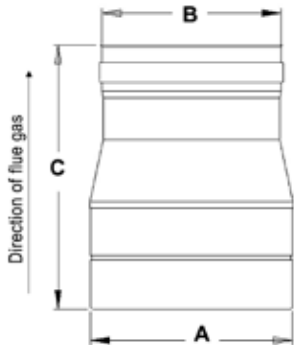

Used to downsize a vent system

A	B	C	Part Number	Description
12	10,8,7	10	2SVSRO(A)O(B)	Z-Vent Reducer(A)to(B)
10	8,7,6	10	2SVSRO(A)O(B)	Z-Vent Reducer(A)to(B)
8	7,6,5	10	2SVSRO(A)O(B)	Z-Vent Reducer(A)to(B)
7	6,5,4	10	2SVSRO(A)O(B)	Z-Vent Reducer(A)to(B)
6	5,4,3	10	2SVSRO(A)O(B)	Z-Vent Reducer(A)to(B)
5	4,3	10	2SVSRO(A)O(B)	Z-Vent Reducer(A)to(B)
4	3	10	2SVSRO(A)O(B)	Z-Vent Reducer(A)to(B)

Adjustable 18in

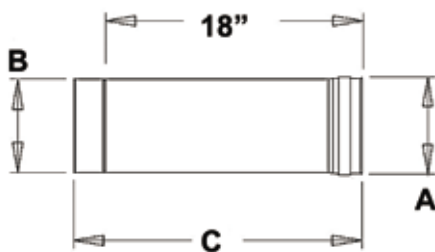

The use of adjustable pipe may be required when the system must be located within extremely tight installation parameters.

A	B	C	Part Number	Description
3	2.925	18	2SVSPA03	Z-Vent Adjustable Pipe 3in
4	3.925	18	2SVSPA04	Z-Vent Adjustable Pipe 4in
5	4.925	18	2SVSPA05	Z-Vent Adjustable Pipe 5in
6	5.925	18	2SVSPA06	Z-Vent Adjustable Pipe 6in
7	6.925	18	2SVSPA07	Z-Vent Adjustable Pipe 7in
8	7.925	18	2SVSPA08	Z-Vent Adjustable Pipe 8in
10	9.925	18	2SVSPA10	Z-Vent Adjustable Pipe 10in
12	11.925	18	2SVSPA12	Z-Vent Adjustable Pipe 12in
14	13.925	18	2SVSPA14	Z-Vent Adjustable Pipe 14in
16	15.925	18	2SVSPA16	Z-Vent Adjustable Pipe 16in
18	17.925	18	2SVSPA18	Z-Vent Adjustable Pipe 18in
20	19.925	18	2SVSPA20	Z-Vent Adjustable Pipe 20in
22	21.925	18	2SVSPA22	Z-Vent Adjustable Pipe 22in
24	23.925	18	2SVSPA24	Z-Vent Adjustable Pipe 24in

Z-Vent single Wall AL29-4C Special Gas Vent



Flashing Flat

Flat flashing provides weather protection where the vent penetrates the roof or chimney. Use on flat or slightly sloped (5° slope maximum) roofs.

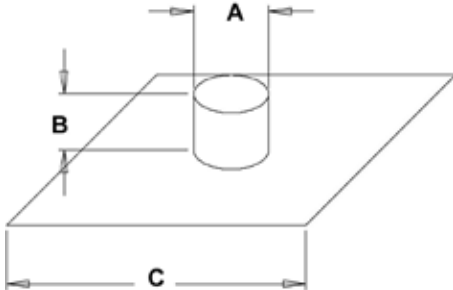

A	B	C	Part Number	Description
3	4	16	2SVSSCF03	Z-Vent Flashing Flat 3in
4	4	16	2SVSSCF04	Z-Vent Flashing Flat 4in
5	4	16	2SVSF05	Z-Vent Flashing Flat 5in
6	4	16	2SVSF06	Z-Vent Flashing Flat 6in
7	4	16	2SVSF07	Z-Vent Flashing Flat 7in
8	4	16	2SVSF08	Z-Vent Flashing Flat 8in
10	4	18	2SVSF10	Z-Vent Flashing Flat 10in
12	4	24	2SVSF12	Z-Vent Flashing Flat 12in
14	4	26	2SVSF14	Z-Vent Flashing Flat 14in
16	4	28	2SVSF16	Z-Vent Flashing Flat 16in
18	4	30	2SVSF18	Z-Vent Flashing Flat 18in
20	4	32	2SVSF20	Z-Vent Flashing Flat 20in
22	4	34	2SVSF22	Z-Vent Flashing Flat 22in
24	4	36	2SVSF24	Z-Vent Flashing Flat 24in

Flashing 0-30°

0-30° flashing provides weather protection where the vent penetrates the roof. Use on roofs with a pitch from 5-30°- 0/12-5/12 slope

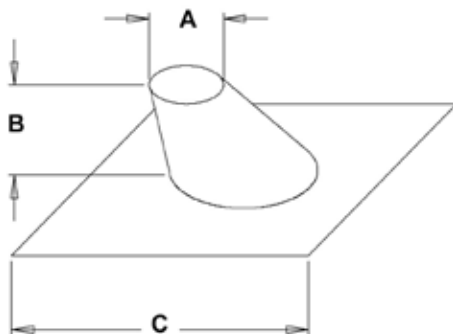

A	B	C	Part Number	Description
3	6	16	2SVSADJF03	Z-Vent 0-30° Flashing 3in
4	6	16	2SVSADJF04	Z-Vent 0-30° Flashing 4in
5	6	18	2SVSFA05	Z-Vent 0-30° Flashing 5in
6	6	20	2SVSFA06	Z-Vent 0-30° Flashing 6in
7	6	22	2SVSFA07	Z-Vent 0-30° Flashing 7in
8	6	24	2SVSFA08	Z-Vent 0-30° Flashing 8in
10	6	26	2SVSFA10	Z-Vent 0-30° Flashing 10in
12	6	28	2SVSFA12	Z-Vent 0-30° Flashing 12in
14	6	30	2SVSFA14	Z-Vent 0-30° Flashing 14in
16	6	32	2SVSFA16	Z-Vent 0-30° Flashing 16in
18	6	34	2SVSFA18	Z-Vent 0-30° Flashing 18in
20	6	36	2SVSFA20	Z-Vent 0-30° Flashing 20in
22	6	38	2SVSFA22	Z-Vent 0-30° Flashing 22in
24	6	40	2SVSFA24	Z-Vent 0-30° Flashing 24in

Z-Vent single Wall AL29-4C Special Gas Vent



Wall Thimble

For use when the vent passes through a horizontal opening. Not required for non-combustible walls.

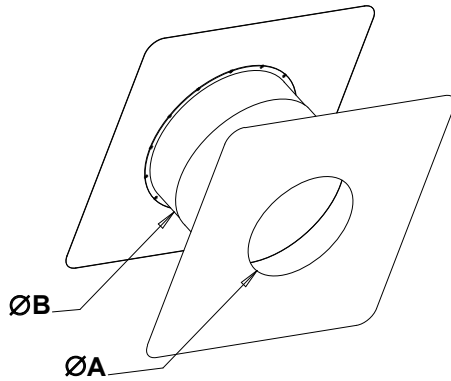

A	B	Part Number	Description
3	5	2SVSWTX03	Z-Vent wall thimble 3 in
4	6	2SVSWTX04	Z-Vent wall thimble 4 in
5	7	2SVSWTX05	Z-Vent wall thimble 5 in
6	18.625	2SVSWT06	Z-Vent wall thimble 6 in
7	19.375	2SVSWT07	Z-Vent wall thimble 7 in
8	20.375	2SVSWT08	Z-Vent wall thimble 8 in
10	22.125	2SVSWT10	Z-Vent wall thimble 10 in
12	24.125	2SVSWT12	Z-Vent wall thimble 12 in
14	26.125	2SVSWT14	Z-Vent wall thimble 14 in
16	28.125	2SVSWT16	Z-Vent wall thimble 16 in
18	30.125	2SVSWT18	Z-Vent wall thimble 18 in
20	32.125	2SVSWT20	Z-Vent wall thimble 20 in
22	34.125	2SVSWT22	Z-Vent wall thimble 22 in
24	36.125	2SVSWT24	Z-Vent wall thimble 24 in

Storm Collar

For use in conjunction with flashing to provide weather protection

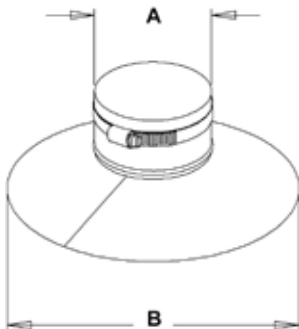

A	B	Part Number	Description
3	7	2SVSLSF03	Z-Vent Storm Collar 3in
4	8	2SVSLSF04	Z-Vent Storm Collar 4in
5	9	2SVSLS05	Z-Vent Storm Collar 5in
6	10	2SVSLS06	Z-Vent Storm Collar 6in
7	11	2SVSLS07	Z-Vent Storm Collar 7in
8	12	2SVSLS08	Z-Vent Storm Collar 8in
10	14	2SVSLS10	Z-Vent Storm Collar 10in
12	16	2SVSLS12	Z-Vent Storm Collar 12in
14	18	2SVSLS14	Z-Vent Storm Collar 14in
16	20	2SVSLS16	Z-Vent Storm Collar 16in
18	22	2SVSLS18	Z-Vent Storm Collar 18in
20	24	2SVSLS20	Z-Vent Storm Collar 20in
22	26	2SVSLS22	Z-Vent Storm Collar 22in
24	28	2SVSLS24	Z-Vent Storm Collar 24in

Z-Vent single Wall AL29-4C Special Gas Vent



Guy Band

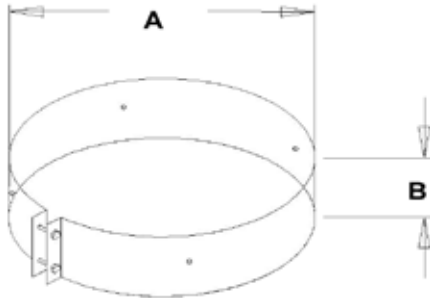

A guy band is used to stabilize the vent above the roof line or where a vent support can not be used. Secure with 4 guy wires (not included).

A	B	Part Number	Description
3	3	2SVSGB03	Z-Vent Guy Band 3in
4	3	2SVSGB04	Z-Vent Guy Band 4in
5	3	2SVSGB05	Z-Vent Guy Band 5in
6	3	2SVSGB06	Z-Vent Guy Band 6in
7	3	2SVSGB07	Z-Vent Guy Band 7in
8	3	2SVSGB08	Z-Vent Guy Band 8in
10	3	2SVSGB10	Z-Vent Guy Band 10in
12	3	2SVSGB12	Z-Vent Guy Band 12in
14	3	2SVSGB14	Z-Vent Guy Band 14in
16	3	2SVSGB16	Z-Vent Guy Band 16in
18	3	2SVSGB18	Z-Vent Guy Band 18in
20	3	2SVSGB20	Z-Vent Guy Band 20in
22	3	2SVSGB22	Z-Vent Guy Band 22in
24	3	2SVSGB24	Z-Vent Guy Band 24in

Firestop Support

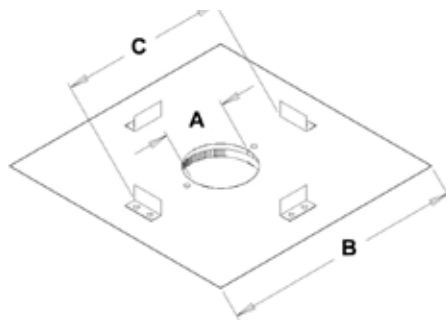

for sizes 3" & 4"

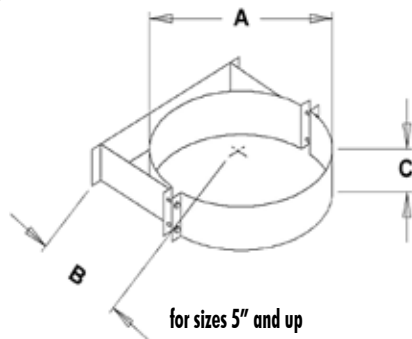

for sizes 5" and up

A fire stop is used on vertical systems to provide support and maintain the necessary clearance to combustible materials. (For sizes 5" and up gear clamp comes loose with no gear clamp bracket.)

A	B	C	Part Number	Description
3	19	15	2SVSFSSF03	Z-Vent Fire Stop Support 3in
4	20	16	2SVSFSSF04	Z-Vent Fire Stop Support 4in
5	21	17	2SVSFSS05	Z-Vent Fire Stop Support 5in
6	22	18	2SVSFSS06	Z-Vent Fire Stop Support 6in
7	23	19	2SVSFSS07	Z-Vent Fire Stop Support 7in
8	24	20	2SVSFSS08	Z-Vent Fire Stop Support 8in
10	26	22	2SVSFSS10	Z-Vent Fire Stop Support 10in
12	28	24	2SVSFSS12	Z-Vent Fire Stop Support 12in
14	30	26	2SVSFSS14	Z-Vent Fire Stop Support 14in
16	32	28	2SVSFSS16	Z-Vent Fire Stop Support 16in
18	34	30	2SVSFSS18	Z-Vent Fire Stop Support 18in
20	36	32	2SVSFSS20	Z-Vent Fire Stop Support 20in
22	38	34	2SVSFSS22	Z-Vent Fire Stop Support 22in
24	40	36	2SVSFSS24	Z-Vent Fire Stop Support 24in

Z-Vent single Wall AL29-4C Special Gas Vent



Vent Support

Vent supports are used to provide support to the vent system while maintaining proper clearance to combustible materials. As vertical supports are required after any 10 foot run. These supports may also be used to support long horizontal runs, which require support every 6 feet.

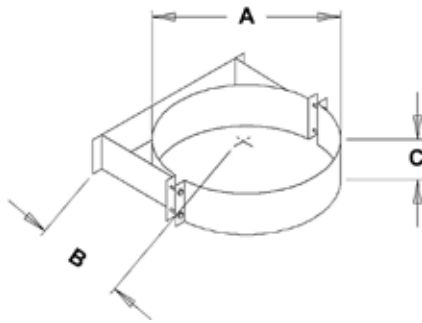

A	B	C	Part Number	Description
3	2.5	3	2SVSWS03	Z-Vent single wall support 3in
4	3.0	3	2SVSWS04	Z-Vent single wall support 4in
5	4.5	3	2SVSWS05	Z-Vent single wall support 5in
6	5	3	2SVSWS06	Z-Vent single wall support 6in
7	5.5	3	2SVSWS07	Z-Vent single wall support 7in
8	6	3	2SVSWS08	Z-Vent single wall support 8in
10	7	3	2SVSWS10	Z-Vent single wall support 10in
12	8	3	2SVSWS12	Z-Vent single wall support 12in
14	9	3	2SVSWS14	Z-Vent single wall support 14in
16	10	3	2SVSWS16	Z-Vent single wall support 16in
18	11	3	2SVSWS18	Z-Vent single wall support 18in
20	12	3	2SVSWS20	Z-Vent single wall support 20in
22	13	3	2SVSWS22	Z-Vent single wall support 22in
24	14	3	2SVSWS24	Z-Vent single wall support 24in

Base Support

Base supports are designed to support the vent base and maintain proper clearance to combustibles.

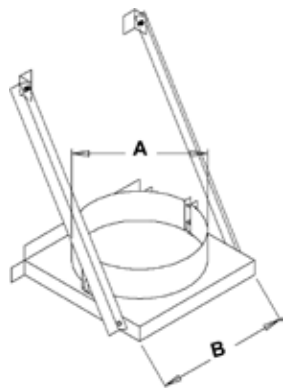

A	B	Part Number	Description
3	7.125	2SVSBS03	Z-Vent single base support 3in
4	8.125	2SVSBS04	Z-Vent single base support 4in
5.125	9.125	2SVSBS05	Z-Vent single base support 5in
6.125	10.125	2SVSBS06	Z-Vent single base support 6in
7.125	11.125	2SVSBS07	Z-Vent single base support 7in
8.125	12.125	2SVSBS08	Z-Vent single base support 8in
10.125	14.125	2SVSBS10	Z-Vent single base support 10in
12.125	16.125	2SVSBS12	Z-Vent single base support 12in
14.125	18.125	2SVSBS14	Z-Vent single base support 14in
16.125	20.125	2SVSBS16	Z-Vent single base support 16in
18.125	22.125	2SVSBS18	Z-Vent single base support 18in
20.125	24.125	2SVSBS20	Z-Vent single base support 20in
22.125	26.125	2SVSBS22	Z-Vent single base support 22in
24.125	28.125	2SVSBS24	Z-Vent single base support 24in

Z-Vent single Wall AL29-4C Special Gas Vent



Horizontal Drain

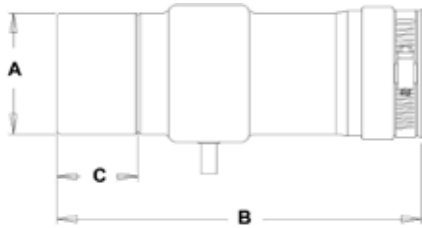

A horizontal drain pipe is used to drain condensate from the vent system. The drain should be positioned as close as possible to the appliance and vent sloped towards it.

A	B	C	Part Number	Description
3	9	2	2SVEDWC03	Z-Vent Horizontal Drainpipe 3"
4	9	2	2SVEDWC04	Z-Vent Horizontal Drainpipe 4"

Vertical Drain Tee

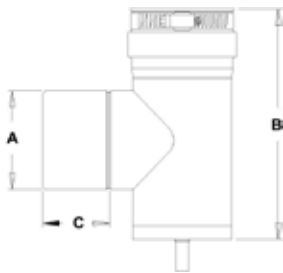

A vertical drain pipe is used to drain condensate from the vent system. The drain should be positioned as close as possible to the appliance. High temperature silicone drain tube kit sold separately.

A	B	C	Part Number	Description
3	7	2	2SVEVWC04	Z-Vent Vertical Drainpipe 3"
4	10	2	2SVEVWC04	Z-Vent Vertical Drainpipe 4"

Extended Wall Thimble

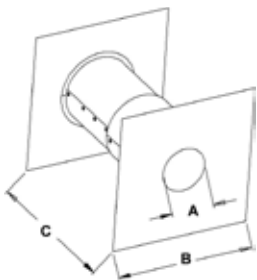

For use when the vent passes through a horizontal opening. Not required for non-combustible walls.

A	B	C	Part Number	Description
3	10	6-11	2SVSWTE03	3in exterior wall thimble
4	10	6-11	2SVSWTE04	4in exterior wall thimble

Termination Tee

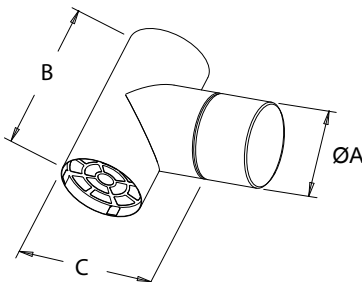

Used to terminate a horizontal or vertical

A	B	C	Part Number	Description
3	6	5	2SVSTTX03	Z-Vent Termination Tee 3in.
4	7	6	2SVSTTX04	Z-Vent Termination Tee 4in.

Z-Vent single Wall AL29-4C Special Gas Vent



Termination Elbow

Used to terminate a horizontal vent

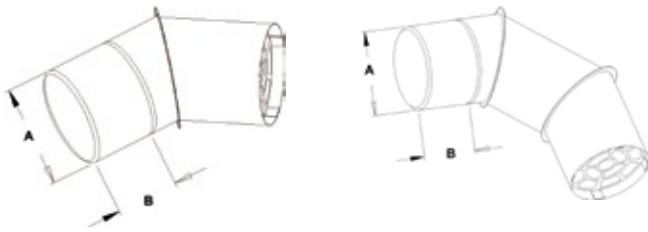

A	B	Part Number	Description
3	2	2SVSTEX0345	Z-Vent Termination Elbow 3 x 45
3	2	2SVSTEX0390	Z-Vent Termination Elbow 3 x 90
4	2	2SVSTEX0445	Z-Vent Termination Elbow 4 x 45
4	2	2SVSTEX0490	Z-Vent Termination Elbow 4 x 90

Termination Hood*

Used to terminate a horizontal vent section

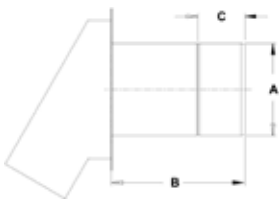

*Designed for use with Takagi Water Heaters

A	B	C	Part Number	Description
3	5.75	2	2SVSHTX03	Z-Vent Termination Hood 3in
4	5.75	2	2SVSHTX04	Z-Vent Termination Hood 4in

Termination Coupling

Used to terminate a horizontal vent section

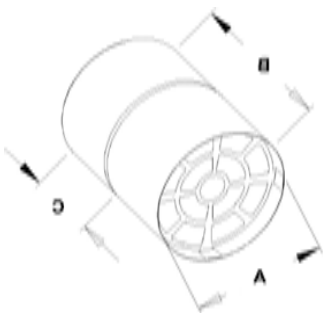

A	B	C	Part Number	Description
3	4.25	2	2SVSTPX03	Z-Vent Termination Couplings 3in
4	4.25	2	2SVSTPX04	Z-Vent Termination Couplings 4in

Z-Vent single Wall AL29-4C Special Gas Vent



Steep Roof Flashing

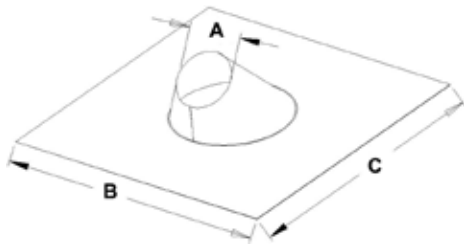

Used where a vertical vent section passes through the roof. Accommodates roof pitches from 40° to 90° - 8/12-12/12. Storm collar sold separately.

A	B	C	Part Number	Description
3.25	16	16	2SVSADJS03	Steep Roof Flashing 3in
4.25	16	16	2SVSADJS04	Steep Roof Flashing 4in

Vertical Drain Pipe

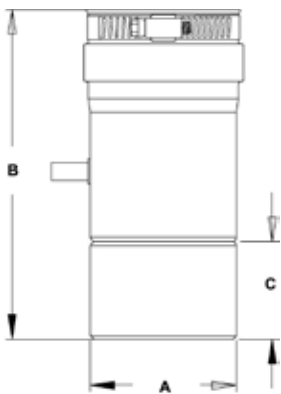

Used on vertical runs to drain condensate from the system. The drain should be positioned as close as possible to the appliance. High temperature silicone tube kit sold separately.

A	B	C	Part Number	Description
3	6.75	2	2SVSEVDP03	Z-Vent Vertical Drain Pipe 3in
4	6.75	2	2SVSEVDP04	Z-Vent Vertical Drain Pipe 4in

Adapter 6in (Double Female)

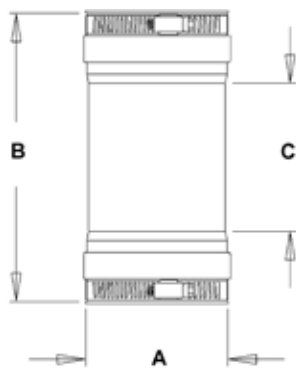

This special section is to adapt the appliance collar to the Z-Vent pipe

A	B	C	Part Number	Description
3	6	2	2SVSNA03.5	Z-Vent appliance adapter 3in
4	6	2	2SVSNA04.5	Z-Vent appliance adapter 4in
5	6	2	2SVSA05	Z-Vent appliance adapter 5in
6	6	2	2SVSA06	Z-Vent appliance adapter 6in
7	6	2	2SVSA07	Z-Vent appliance adapter 7in
8	6	2	2SVSA08	Z-Vent appliance adapter 8in
10	6	2	2SVSA10	Z-Vent appliance adapter 10in
12	6	2	2SVSA12	Z-Vent appliance adapter 12in
14	6	2	2SVSA14	Z-Vent appliance adapter 14in
16	6	2	2SVSA16	Z-Vent appliance adapter 16in
18	6	2	2SVSA18	Z-Vent appliance adapter 18in
20	6	2	2SVSA20	Z-Vent appliance adapter 20in
22	6	2	2SVSA22	Z-Vent appliance adapter 22in
24	6	2	2SVSA24	Z-Vent appliance adapter 24in

Z-Vent Single Wall AL29-4C Special Gas Vent



Weil-Mclain Adaptor

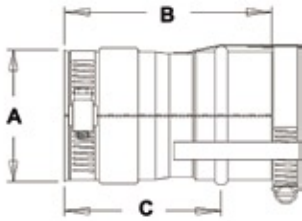

A	B	C	Part Number	Description
3	4.25	3.25	2SVEMGVX03	Weil-Mclain GV Starter 3in (Series 2)

Weil-Mclain CGI Adaptor

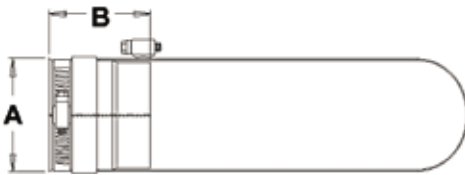

A	B	Part Number	Description
3	3	2SVEWMFAF03	Weil-Mclain CGI Adaptor 3in

Weil-Mclain Starter Tee Series 3/4 Adaptor

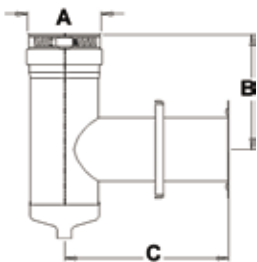

A	B	C	Part Number	Description
3	5.5	7	2SVEVSTF03	Weil-Mclain Starter Tee 3in (Series 3 & 4)

Safety Vent Adaptor

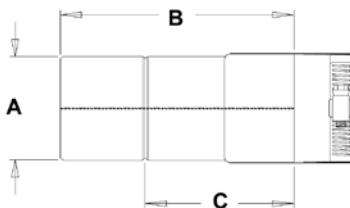

A	B	C	Part Number	Description
3	5.5	3.5	2SVSSVA03	Safety Vent Adaptor 3in Coax

Z-Vent single Wall AL29-4C Special Gas Vent



Buderus Adaptor

A	B	Part Number	Description
3	4.25	2SVB03	Z-Vent Buderus GA 124 244
4	4.25	2SVB04	Z-Vent Buderus GA 124 244

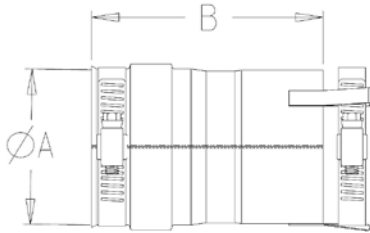

Burnham, Triangle Tube Adaptor

A	B	Part Number	Description
3	4	2SVSTA03	Burnham PV2/ Triangle Tube Adaptor

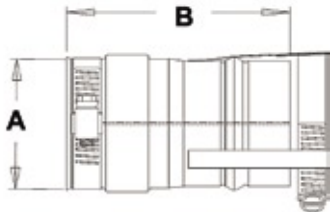

Ametek Fan Adaptor

A	B	Part Number	Description
3	4.75	2SVSACAF03	Ametek Fan Adaptor 3in

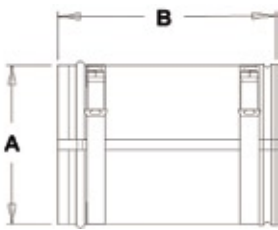

Locking Bands

A	B	Part Number	Description
3	4	2SVSLBF03	Z-Vent Locking Band 3in
4	4	2SVSLBF04	Z-Vent Locking Band 4in

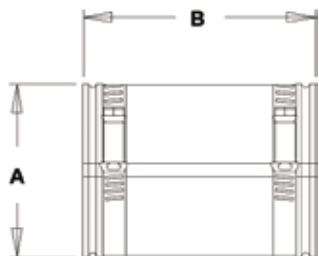

Z-Vent Single Wall AL29-4C Special Gas Vent



Modine Adaptor

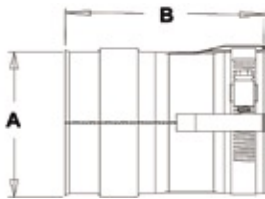

A	B	Part Number	Description
4	4	2SVMPE04	Z-Vent Modine PDP 125 Adaptor 4in

Slant Fin Victory, Concept, VSPH Adaptor

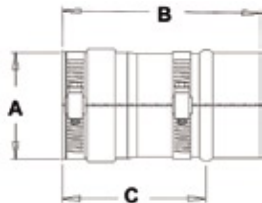

A	B	C	Part Number	Description
3	5.5	4	2SVSSLA2	Slantfin Victory, Concept, VSPH Adaptor

Slant Fin Termination Adaptor

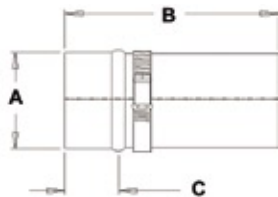

A	B	C	Part Number	Description
3	6	1.5	2SVSSLA1	Slantfin Termination Adaptor

Smith/Hydrotherm Adaptor

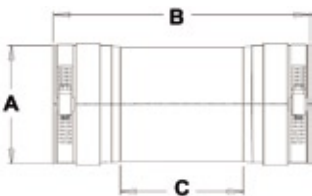

A	B	C	Part Number	Description
4	18	4	2SVESHA04	4in Smith/Hydrotherm Adaptor

Z-Vent Single Wall AL29-4C Special Gas Vent



Sta-Rite Adaptor

A	B	Part Number	Description
4	8.25	4STPHA04	Sta-Rite Connector

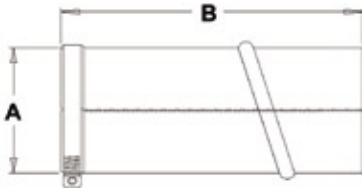

Utica Adaptor

A	B	Part Number	Description
3	3.75	2SVSUBAF03	Utica Boiler Adaptor 3in
4	3.75	2SVSUBAF04	Utica Boiler Adaptor 4in



Viessmann Vitoden Adaptor

A	B	C	Part Number	Description
3	6	4	2SVSVB03	Adaptor Vitoden 3in
4	6	4	2SVSVB04	Adaptor Vitoden 4in

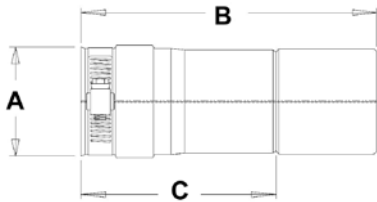

Viessmann Vitogas Adaptor

A	B	C	Part Number	Description
8	6	2	2SVSA08	8in Appliance Adaptor

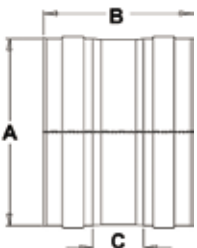

Z-Vent Single Wall AL29-4C Special Gas Vent



Bosch Adaptor

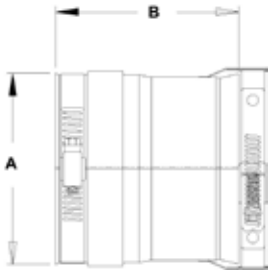

A	B	Part Number	Description
4	4	2SVFX04	Bosch 125 FX Adaptor 4in

Noritz Adaptor

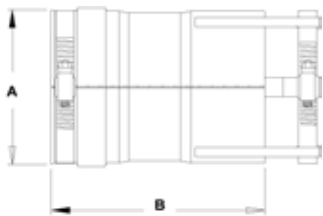

A	B	Part Number	Description
4	6	2SVWA03	Z-Vent Adaptor Noritz 3in
4	6	2SVWA04	Z-Vent Adaptor Noritz 4in
4	6	2SVWA05	Z-Vent Adaptor Noritz 5in

Adaptor Aerco

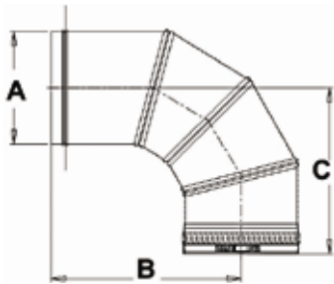

A	B	C	Part Number	Description
8	13.5	11.75	2SVAER0890	Adaptor Aerco 8 X 90