

Troubleshooting

Table 1: Troubleshooting

Symptom	Action
CSS solid state output does not function	Verify that the maximum amperage range has not been exceeded. Voltages or currents above the rated levels may damage the CSS.
Setpoint screw keeps turning	The setpoint screw has a slip clutch to prevent damage at either end. To return the LED to the original setting, turn the setpoint screw 20 full turns counterclockwise and start the calibration procedure again.
Motor is turned on and switch does not close	Insufficient current to the load leads (for example, a motor or heater) to reach the setpoint threshold. To turn the switch on, wrap the cable multiple times through the sensing hole (see Figure 4.)

Technical Specifications

Model CSSGFN025NN / CSSGA2100NN

	CSSGFN025NN	CSSGA2100NN
Amperage Range	0.25 to 200 A	1.00 to 135 A
Continuous Operating Current	200 A, 600V AC	135 A, 600V AC
Switch Setpoint	Fixed	Adjustable
Output Relay	No	No
LED Indication	No	Yes
Actuation Coil	No	No
Current Switching Mode	Under current sensing	Over/Under current sensing
Trip Setpoint Mode	0.25 A	1.00 to 135 A
Sensor Supply Voltage	Induced from power conductor cable	Induced from power conductor cable
Status Output	Switch normally open	Switch normally open
Switch Load Capacity	30V AC/DC max., 1 A max.	30V AC/DC max., 1 A max.
Isolation Voltage	600V AC rms	600V AC rms
Temperature Range	5 to 140°F (-15 to 60°C)	5 to 140°F (-15 to 60°C)
Frequency Range	50/60 Hz	50/60 Hz
Humidity Range	0 to 95% noncondensing	0 to 95% noncondensing
Dimensions	2.54 x 1.85 x 1.08 in. (65 x 47 x 27 mm)	2.54 x 1.85 x 1.08 in. (65 x 47 x 27 mm)
Aperture (Sensing Hole) Size	0.71 in. Dia. (18 mm Dia.)	0.71 in. Dia. (18 mm Dia.)
Compliance	United States: UL Listed, File E317719 CCN NRNT, Under UL 508, Industrial Control Equipment Canada: UL Listed, File E317719 CCN NRNT7, Under CAN/CAS C22.2 No. 14-05, Industrial Control Equipment Europe: CE Mark LVD 2006/95/EC, EMC Directive 2004/108/EC	

SSCSS Rev. C 09/15/2009

For all CE technical questions, contact Setra Systems, USA. EU customers may contact our EU representative Hengstler GmbH, Umlandstr 49, 78554 Aldingen, Germany (Tel: +49-7424-890; Fax: +49-7424-89500).

The performance specifications are nominal and conform to acceptable industry standards. For application of conditions beyond these specifications, consult your local Setra representative.

59 Swanson Road, Boxborough, MA 01719/800-257-3872;

Fax: 978-264-0292; Email: sales@setra.com/Web: www.setra.com



setra CSS Series - Current Switch Solid

Model CSSGFN025NN / CSSGA2100NN

Installation Instructions



Introduction

The Current Switch Solid (CSS) Series of digital output switches are noninvasive devices designed to detect low current flowing through a cable or wire. A cost effective solution for monitoring on and off status or proof of operation, these units are ideal for monitoring small current loads on motors driving fans and blowers, and for sensing the status of heating coils, and lighting.

These units provide a universal solid state output and do not require a power supply. Excitation is magnetically induced from current carrying conductor (wire or cable), making these units completely self-powered.

IMPORTANT: The Current Switch Device (CSS) Series Current Devices are intended to provide an input to equipment under normal operating conditions. Where failure or malfunction of the CSS could lead to personal injury or property damage to the controlled equipment or other property, additional precautions must be designed into the control system. Incorporate and maintain other devices such as supervisory or alarm systems or safety or limit controls intended to warn of, or protect against, failure or malfunction of the CSS.

Installation

Caution, Risk of Electric Shock
Disconnect power supply before making electrical connections. Contact with components carrying hazardous voltage can cause electric shock and may result in severe personal injury or death.

Dimensions

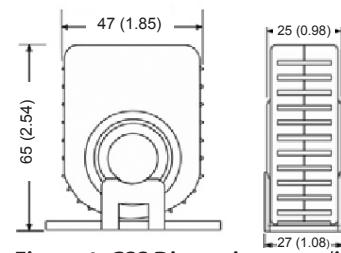

Figure 1: CSS Dimensions mm (in.)

Mounting

- Using the two screws (included), attach the mounting bracket to the back of the electrical enclosure.
- Snap the CSS into place on the mounting bracket.

Wiring

- Disconnect power to the conductor cable from the power source.
 - Slide the power conductor cable through the sensing hole of the CSS.
- Note:** The switch contacts are solid state, and they work just like dry contacts. When the switch is closed, less than 1 ohm is present; when the switch is open, more than 1 megohm is present.
- Wire CSS output terminals to the control box Digital Input (DI) terminal (30 V maximum terminal voltage).
 - Reconnect the power conductor cable (see Figure 2 and Figure 3 for wiring examples).
 - Calibrate Model CSSGA2100NN (see Setup and Adjustments).

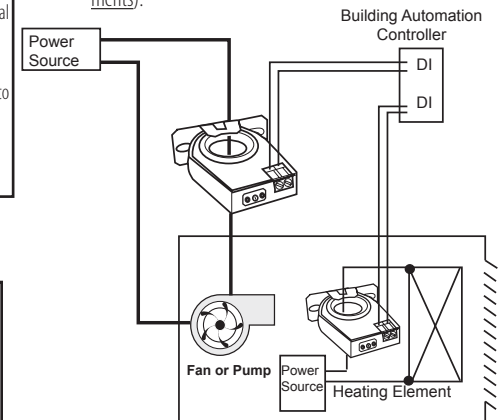

Figure 2: CSSGFN025NN

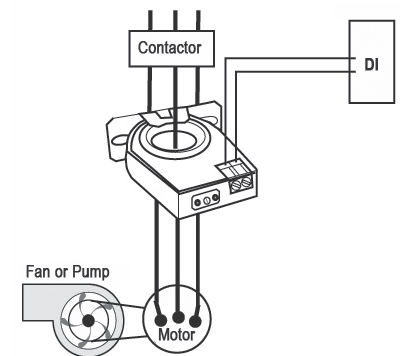

Figure 3: CSSGA2100NN

If the measured current is too low to be detected or is higher than the maximum current rating of the CSS, use the following methods to increase or decrease current:

IF Measured Current is Too Low to be Detected

Wrap the conductor (wire) through the sensing hole and around the CSS body to produce multiple turns to increase the measured current.

Measured current = actual current multiplied by the number of turns (see Figure 4).



Figure 4: CSS Shown with Four Turns

IMPORTANT: Failure to derate the current capacity could result in damage to the CSS when using multiple turns to increase measured current. Use the following formula to determine the new maximum current:

New Maximum Current = CSS Current Rating/number of turns
 For example, Model CSSGA2100NN with 4 turns = 135 A/4 = 33.8 A, new maximum current.)

To Monitor Currents Exceeding the Maximum Current Rating of the CSS

For currents >200 A (Model CSSGFN025NN) (Model CSSGA2100NN)

Use a 5 A Current Transformer (CT) to reduce the current passing through the CSS as shown in Figure 5. Run the current transformer secondary wire through the sensing hole. Terminate the two secondary wires of the 5 A current transformer to each other, and then install the 5 A current transformer on the conductor being monitored.

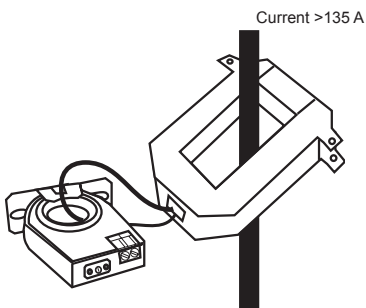

Figure 5: CSS with CT Transformer

Setup and Adjustments

Calibration

CSS Series Model CSSGA2100NN

Position the CSS so the status output panel faces you. Confirm the monitored load (for example, a motor or heater) is running, and then use the following methods to calibrate the CSS.

Under current Status Condition (Belt Loss, Coupling Shear, Fan, and Pump Status)

1. Turn the setpoint screw clockwise until the Status Closed Light-Emitting Diode (LED) turns off and the Status Open LED turns on.

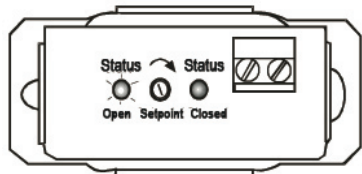

Figure 6: Status Open, LED On

2. Slowly turn the setpoint screw counterclockwise until the Status Closed LED turns on and the Status Open LED turns off.

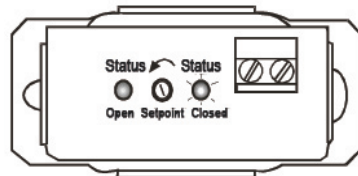

Figure 7: Status Open, LED Off

3. Turn the setpoint screw an additional 1/4 turn counterclockwise to create a deadband to prevent hunting.

The CSS is now calibrated to signal current flows below normal full load amperes.

Output Status:

- Normal: Output Closed
- Alarm: Output Open

Over Current Status Condition (Locked Rotor, Seized Impeller)

1. Turn the setpoint screw counterclockwise until the Status Open LED turns off and the Status Closed LED turns on.

Note: This is the default factory setting.

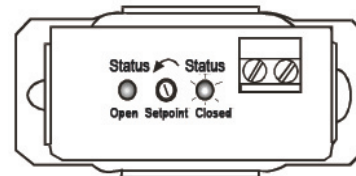

Figure 8: Status Closed, LED On

2. Slowly turn the setpoint screw clockwise until the Status Closed LED turns off and the Status Open LED turns on.

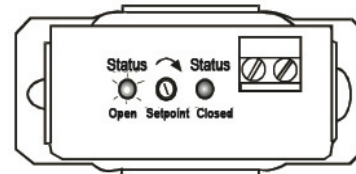

Figure 9: Status Open, LED On

3. Turn the setpoint screw an additional 1/4 turn clockwise to create a deadband to prevent hunting.

The CSS is now calibrated to signal current flows above normal full load amperes.

Output Status:

- Normal: Output Open
- Alarm: Output Closed

RETURNING PRODUCTS FOR REPAIR

Please contact a Setra application engineer (800-257-3872, 978-263-1400) before returning unit for repair to review information relative to your application. Many times only minor field adjustments may be necessary. When returning a product to Setra, the material should be carefully packaged, and shipped to:

Setra Systems, Inc.
 159 Swanson Road
 Boxborough, MA 01719-1304
 Attn: Repair Department

To assure prompt handling, returned unit(s) must be accompanied by Setra's Return Order Form, completely filled out, found on Setra's web site at http://www.setra.com/tra/repairs/cal_rep.htm.

Notes: Please remove any pressure fittings and plumbing that you have installed and enclose any required mating electrical connectors and wiring diagrams.

Allow approximately 3 weeks after receipt at Setra for the repair and return of the unit.

Non-warranty repairs will not be made without customer approval and a purchase order to cover repair charges.

Calibration Services

Setra maintains a complete calibration facility that is traceable to the National Institute of Standards & Technology (NIST). If you would like to recalibrate or recertify your Setra pressure transducers or transmitters, please call our Repair Department at 800-257-3872 (978-263-1400) for scheduling.

WARRANTY AND LIMITATION OF LIABILITY

SETRA warrants its products to be free from defects in materials and workmanship, subject to the following terms and conditions. Without charge, SETRA will repair or replace products found to be defective in materials or workmanship within the warranty period; provided that:

- a) the product has not been subjected to abuse, neglect, accident, incorrect wiring not our own, improper installation or servicing, or use in violation of instructions furnished by SETRA;
- b) the product has not been repaired or altered by anyone except SETRA or its authorized service agencies;
- c) the serial number or date code has not been removed, defaced, or otherwise changed; and
- d) examination discloses, in the judgment of SETRA, the defect in materials or workmanship developed under normal installation, use and service;
- e) SETRA is notified in advance of and the product is returned to SETRA transportation prepaid.

Unless otherwise specified in a manual or warranty card, or agreed to in writing and signed by a SETRA officer, SETRA pressure and acceleration products shall be warranted for one year from date of sale. The foregoing warranty is in lieu of all warranties, express, implied or statutory, including but not limited to, any implied warranty of merchantability for a particular purpose. SETRA's liability for breach of warranty is limited to repair or replacement, or if the goods cannot be repaired or replaced, to a refund of the purchase price. SETRA's liability for all other breaches is limited to a refund of the purchase price. In no instance shall SETRA be liable for incidental or consequential damages arising from a breach of warranty, or from the use or installation of its products.

No representative or person is authorized to give any warranty other than as set out above or to assume for SETRA any other liability in connection with the sale of its products.