

# Installation Manual

## SER200

### Energy Recovery Ventilators



Your ventilation system should be installed in conformance with the appropriate provincial/state requirements or, in the absence of such requirements, with the current edition of the National Building Code, and / or ASHRAE's "Good Engineering Practices".

#### United States

10048 Industrial Blvd., Lenexa, KS, 66215  
Tel.: 800.747.1762 • Fax: 800.487.9915

#### Canada

50 Kanalfakt Way, Bouctouche, NB, E4S 3M5  
Tel.: 800.565.3548 • Fax: 877.747.8116

Fantech reserves the right to modify, at any time and without notice, any or all of its products' features, designs, components and specifications to maintain their technological leadership position. Please visit our website [www.fantech.net](http://www.fantech.net) for more detailed technical information.

				
Note	Warning/ Important note	Information	Technical information	Practical tip



## PLEASE READ AND SAVE THESE INSTRUCTIONS

### For residential use only

Before installation careful consideration must be given to how this system will operate if connected to any other piece of mechanical equipment, i.e. a forced air furnace or air handler operating at a higher static pressure. After installation, the compatibility of the two pieces of equipment must be confirmed by measuring the airflow of the ENERGY Recovery Ventilator using the balancing procedure found in this manual. It is always important to assess how the operation of any ERV may interact with vented combustion equipment (i.e. Gas Furnaces, Oil Furnaces, Wood Stoves, etc.)



Products are designed and manufactured to provide reliable performance, but they are not guaranteed to be 100% free of defects. Even reliable products will experience occasional failures, and this possibility should be recognized by the user. If these products are used in a life support ventilation system where failure could result in loss or injury, the user should provide adequate back-up ventilation, supplementary natural ventilation or failure alarm system, or acknowledge willingness to accept the risk of such loss or injury.

Your ventilation system should be installed in accordance with the local building code that is in effect, in absence of such requirements, it is recommended to check with local authorities having jurisdiction in your area prior to installing this product.

# TABLE OF CONTENTS

DETERMINING YOUR AIRFLOW REQUIREMENT .....	4
INSTALLATION EXAMPLES	
Fully dedicated system .....	5
Partially dedicated system .....	6
Simplified Installation .....	7
EXTERIOR DUCTING INSTALLATION	
Weatherhood Location .....	8
Installing the ducting to the weatherhood .....	8
INTERIOR DUCTING INSTALLATION	
General Tips .....	9
Installing duct to ERV .....	9
Supply & Exhaust Air Grilles Location .....	9
ERV INSTALLATION .....	10
AIRFLOW ADJUSTMENT & BALANCING	
Start up procedure .....	11
Airflow balancing .....	11
LOW VOLTAGE CONTROL SYSTEMS .....	13
WIRING DIAGRAM .....	14
TROUBLESHOOTING .....	16
ERV MAINTENANCE CHART .....	17
ERV CORE WASHING INSTRUCTION .....	18
PARTS LIST .....	19

# DETERMINING YOUR AIRFLOW REQUIREMENT

## Room Count Method

Room classification	Number of rooms	CFM (L/s)	CFM Required
Master bedroom		x 10 L/s (20 CFM)	=
Basement	yes or no	if yes add 10 L/s (20 CFM) if no = 0	=
Bedrooms		x 5 L/s (10 CFM)	=
Living room		x 5 L/s (10 CFM)	=
Others		x 5 L/s (10 CFM)	=
Kitchen		x 5 L/s (10 CFM)	=
Bathroom		x 5 L/s (10 CFM)	=
Laundry room		x 5 L/s (10 CFM)	=
Utility room		x 5 L/s (10 CFM)	=
<b>Total Ventilation Requirements (add last column )</b>			<b>=</b>

1 CFM = 0.47 L/s

1 L/s = 2.13 CFM

## ASHRAE method

### Ventilation Air requirements

Floor area		Bedrooms									
Ft <sup>2</sup>	m <sup>2</sup>	1		2		3		4		5	
		CFM	L/s	CFM	L/s	CFM	L/s	CFM	L/s	CFM	L/s
<500	<47	30	128	38	18	45	21	53	25	60	28
501-1000	47-93	45	21	53	24	60	28	68	31	75	35
1001-1500	94-139	60	28	68	31	75	35	83	38	90	42
1501-2000	140-186	75	35	83	38	90	42	98	45	105	49
2001-2500	187-232	90	42	98	45	105	49	113	52	120	56
2501-3000	233-279	105	49	113	52	120	56	128	59	135	63
3001-3500	280-325	120	56	128	59	135	63	143	66	150	70
3501-4000	326-372	135	63	143	66	150	70	158	73	165	77
4001-4500	373-418	150	70	158	73	165	77	173	80	180	84
4501-5000	419-465	165	77	173	80	180	84	188	87	195	91

\* ASHRAE 62.2-2016 Table 4.1, Ventilation and Acceptable Indoor Air Quality in Low-Rise Residential Buildings.



**Bathroom:** If the ERV is going to provide the required local exhaust ventilation for each bathroom with each a continuous 20 CFM (10 L/s), this ventilation rate can be considered as part of the whole-building ventilation rate.

# INSTALLATION EXAMPLES

Example only – duct configuration may differ depending on the model.

## FULLY DEDICATED SYSTEM BEST FOR NEW CONSTRUCTION



1. Stale air is drawn from key areas of the home requiring local exhaust (bathroom, kitchen, laundry room).
2. Fresh air is distributed directly to habitable rooms in the house (bedrooms, living room)
3. The ERV's airflow must be balanced after installation using the procedure found in the section "AIRFLOW BALANCING"

### Suggested installation for:

- Hydronic baseboard
- Infloor heating
- Electric baseboard
- Mini split heat pump

**Benefits:** Provides the best fresh air distribution in the house; lowest operation cost since the furnace/air handler unit is not needed.

## ERV ducting for fully Dedicated System

\* Ductwork layout may differ depending on model

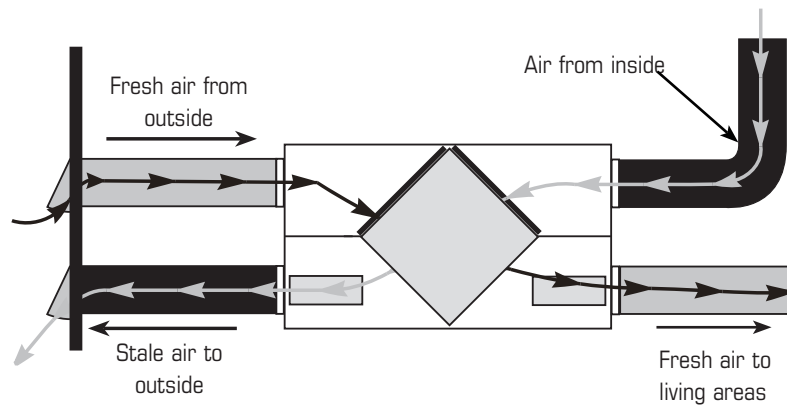

\* Unit air flow should be balanced while ERV is on "Normal" speed and furnace blower is running.

## INSTALLATION EXAMPLES (CONT'D)

DIRECT CONNECTION of the FRESH air to living area to the RETURN PLENUM of the AIR HANDLER (Stale air drawn from key areas of home)

### PARTIALLY DEDICATED SYSTEM (BETTER)



1. In order to provide proper distribution of the fresh air, it is recommended that the furnace blower be set to run continuously or interconnected with ERV. See furnace electrical connection on page 15.
  2. Stale air is drawn from key areas of the home (bathroom, kitchen, laundry room).
  3. Fresh air is supplied to the return air plenum of the furnace.
  4. Due to the difference in pressure between the ERV and the equipment it is being connected to the ERV's airflow must be balanced on site, using the procedure found in the section "AIRFLOW BALANCING"
- \* In the case of a multi-zone system, please contact Fantech customer service prior to installing any installation type requiring the use of the furnace interlock"

#### Suggested installation for:

- Central furnace (air handling unit or central air conditioners)
- When ducting fresh air to living area is not possible or practical, i.e. expensive or when the central AHU will operate year-round.

**Benefits:** Conditions the fresh air prior to distributing it throughout the house



**Make sure the ERV is capable of meeting the required airflow rate.**

### ERV/Furnace ducting for Partially Dedicated System

\* Ductwork layout may differ depending on model

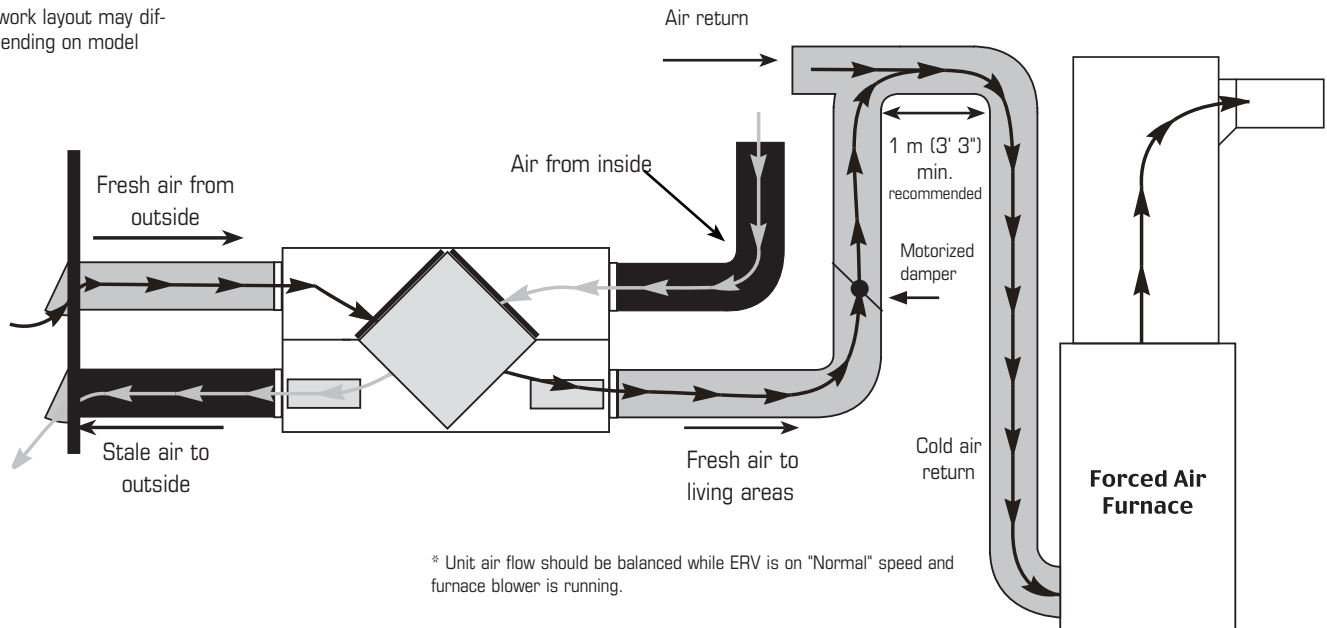

\* Unit air flow should be balanced while ERV is on "Normal" speed and furnace blower is running.



Fantech energy recovery ventilators (ERV) that use a supply fan shutdown for frost prevention do not include an outdoor air motorized damper. If you are using a simplified installation, i.e. connecting the ERV supply air duct to a furnace's return air duct, the ERV must operate continuously. When the ERV is turned off, no warm exhaust air will flow through the ERV but the furnace's fan will continue to draw in outdoor air directly into the furnace. If it's cold outside, cold air will be introduced, without re-heating, directly into the furnace.

If the ERV is installed such that the homeowner may turn off the ERV during the winter, we recommend installing a motorized damper between the ERV's supply air and the furnace's return air duct that closes when the ERV is not operating. See wiring diagram (figure 1). You may also choose to use a Fantech ERV that uses a recirculation defrost that incorporates an outdoor air damper.

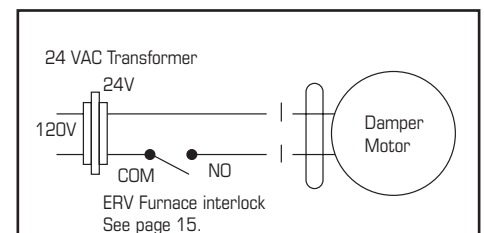

Figure 1

\*Transformer and Damper motor not included

# INSTALLATION EXAMPLES (CONT'D)

DIRECT CONNECTION of both the ERV SUPPLY AIR STREAM and EXHAUST AIR STREAM to the FURNACE COLD AIR RETURN

## SIMPLIFIED INSTALLATION

### (GOOD) (RETURN/RETURN METHOD)

#### Suggested installation for:

- When bathroom and kitchen already have local exhaust system
- May be suitable for retrofitting

**Benefits:** Least expensive installation type



1. Furnace blower must operate when ventilation from ERV is required. The furnace should be set to run continuously or interlocked with ERV. See furnace electrical connection on page 15.
2. A minimum separation of 1 m (39") is recommended between the two direct connections.
3. In order to prevent exhausting any fresh air, the ERV's exhaust air connection should be upstream of the ERV's supply air connection when ducting to the furnace's cold air return.
4. Due to the difference in pressure between the ERV and the equipment it is being connected to the ERV's airflow must be balanced on site, using the procedure found in the section "AIRFLOW BALANCING"

\* In the case of a multi-zone system, please contact Fantech customer service prior to installing any installation type requiring the use of the furnace interlock"

### ERV/Furnace ducting for Simplified Installation - Option 1

\* Ductwork layout may differ depending on model

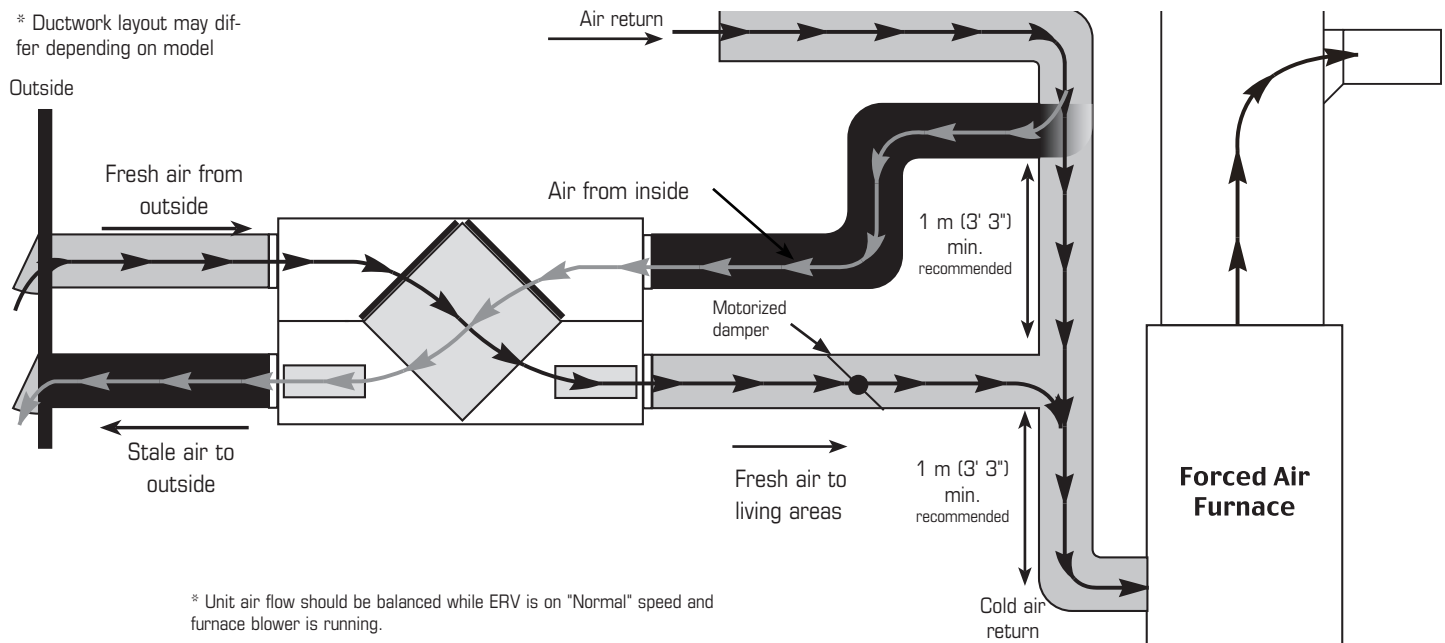

\* Unit air flow should be balanced while ERV is on "Normal" speed and furnace blower is running.



**Fantech energy recovery ventilators (ERV) that use a supply fan shutdown for frost prevention do not include an outdoor air motorized damper. If you are using a simplified installation, i.e. connecting the ERV supply air duct to a furnace's return air duct, the ERV must operate continuously. When the ERV is turned off, no warm exhaust air will flow through the ERV but the furnace's fan will continue to draw in outdoor air directly into the furnace. If it's cold outside, cold air will be introduced, without re-heating, directly into the furnace.**

**If the ERV is installed such that the homeowner may turn off the ERV during the winter, we recommend installing a motorized damper between the HRV's supply air and the furnace's return air duct that closes when the ERV is not operating. See wiring diagram (figure 1). You may also choose to use a Fantech ERV that uses a recirculation defrost that incorporates an outdoor air damper.**

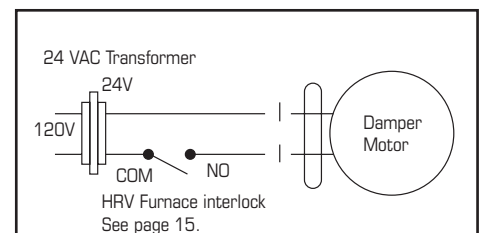

Figure 1

\*Transformer and Damper motor not included

# EXTERIOR DUCTING INSTALLATION

## WEATHERHOOD LOCATION

- Decide where your intake and exhaust hoods will be located.

### Locating the Intake Weatherhood

- Should be located upstream (if there are prevailing winds) from the exhaust outlet.
- At a minimum distance to 900 mm (3') away from dryer vents and furnace exhaust (medium or high efficiency furnaces), driveways, oil fill pipes, gas meters, or garbage containers.
- At a minimum height of 460mm (18") above the ground, or above the level of expected snow accumulation.
- Ideally, keep weatherhoods 1m (3') from corners.
- Do not locate in the garage, attic, crawl space, or underneath deck.

### Locating the Exhaust Weatherhood

- At least 460mm (18") above ground or above the depth of expected snow accumulation
- Ideally, keep weatherhoods 1m (3') from corners.
- Not near a gas meter, electric meter or a walkway where fog or ice could create a hazard
- Do not locate in a garage, workshop or other unheated space

## INSTALLING THE DUCTING TO THE WEATHERHOODS

A well designed and installed ducting system will allow the ERV to operate at its maximum efficiency. The inner liner of the flexible insulated duct must be secured to the sleeve of the weatherhood (as close to the outside as possible) and to the appropriate duct connection on the ERV. The insulation should remain full and not crushed. The outer liner, which acts as a vapor barrier, must be completely sealed to the outer wall and the ERV using tape and/or caulking. A good bead of high quality caulking (preferably acoustical sealant) will seal the inner flexible duct to both the ERV duct connection and the weatherhood prior to securing them.

To minimize airflow restriction, the flexible insulated duct that connects the two outside weatherhoods to the ERV should be stretched tightly and be as short as possible.

Twisting or folding the duct will severely restrict airflow.

See "Installation Diagram Examples" for installation examples.

## STEPS FOR HOOD INSTALLATION:

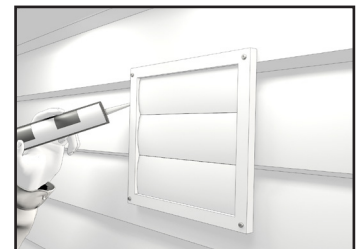
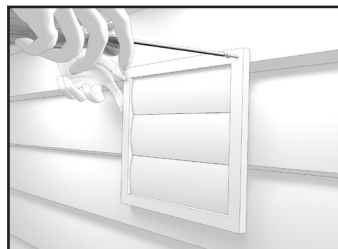
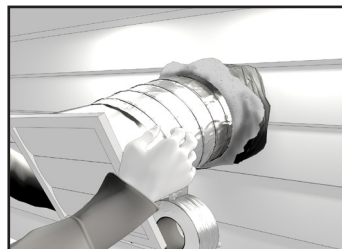
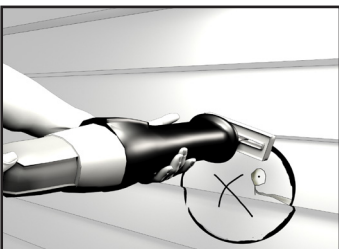

**1** Using the duct connection of the outside hood, outline the intake & exhaust holes to be cut. The holes should be slightly larger than the duct connection to allow for the thickness of the insulated flexible duct. Cut a hole for both the intake and exhaust hoods.

**2** Pull the insulated flexible duct through the opening until it is well extended and straight. Slide the duct's inner vinyl sleeve over the hood duct connection and secure. Pull the insulation over the duct and pull the vapor barrier over the sleeve. Secure with appropriate tape or sealant.

**3** Push the hood into the opening and then attach the hood to the outside wall with mounting screws. Repeat the installation procedure for both the supply and exhaust hoods.

**4** Using a caulking gun, seal around both hoods to prevent any leaks.

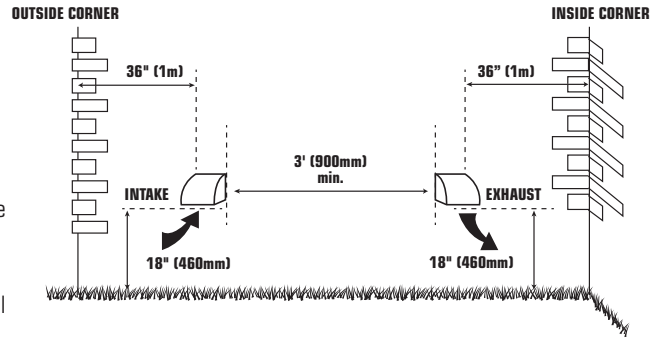

**REQUIRES A WEATHERHOOD WITH A BACKDRAFT DAMPER ON THE EXHAUST SIDE.**

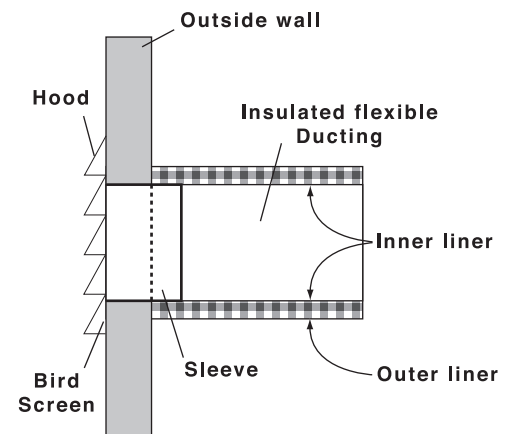



# INTERIOR DUCTING INSTALLATION



- To maximize airflow through the ductwork system, all ducts should be kept short and have as few bends or elbows as possible.
- 45° elbows are preferable to 90°.
- Use “Y” ducts instead of “T” ducts whenever possible.
- All duct joints must be fastened with screws or duct sealant and wrapped with aluminum foil duct tape to prevent leakage.
- Galvanized ducting from the ERV to the living areas in the house is recommended whenever possible, although flexible ducting can be used in moderation when necessary.
- To avoid possible noise transfer through the ductwork system, a short length (approximately 300 mm, 12”) of nonmetallic flexible insulated duct should be connected between the ERV and the supply/exhaust ductwork system.
- The main supply and return line to/from the ERV must have the same diameter as the duct connection or larger.
- Branch lines to the individual rooms may be as small as 100 mm (4”).

## Installing ducting to ERV

For flexible duct installation, slide flexible ducting onto duct connection. Then install a cable tie over flexible duct to prevent leakage between the ducting and the duct connection.

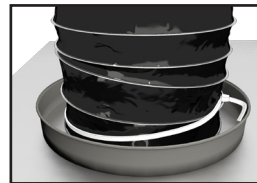

In the case of solid ducting, slide duct over duct connection, screw in place and seal.

## Supply air grilles location

In homes without a forced air furnace, fresh air should be supplied to all habitable rooms, including bedrooms and living areas. It should be supplied from high wall or ceiling locations. Grilles that diffuse the air comfortably are recommended. In homes with a forced air furnace, you may want to connect the ERV to the furnace ductwork (see information below).

## Exhaust air grilles location

The stale air exhaust system is used to draw air from the points in the house where the worst air quality problems occur. It is recommended that return air ducts be installed in the bathroom, kitchen, and laundry room. Additional return air ducts from strategic locations may be installed. The furnace return duct may also be used to exhaust from. In this method, the exhaust air is not ducted back from bathrooms, kitchens, etc to the ERV with “dedicated lines”.



**As per building codes and installation requirements for combustion appliances:**

**Air return ducts, or openings for air return, should not be placed in enclosed spaces containing combustion appliances that are subject to spillage.**

# ERV INSTALLATION



- Have a nearby power supply (120 volts, 60Hz)
- Choose a location which allows the possibility of mounting the unit to supporting beams.
- The unit should be level in order to allow proper condensate drainage
- To minimize noise, do not install unit in living area
- Ensure proper drainage

## LOCATION

The ERV must be located in a conditioned space where it will be possible to conveniently service the unit. Typically the ERV would be located in the mechanical room or an area close to the outside wall where the weatherhoods will be mounted. If a basement area is not convenient or does not exist, a utility room may be used.

**Attic installation** must meet the following conditions:

- Attic temperature must be above freezing conditions at all times and for best performance should be 12°C (54 °F).
- The condensate drain (if included) must be installed so that the condensate drains and is protected from freezing.
- The attic is easily accessible for equipment maintenance and inspection.

**Connecting appliances to the ERV** is not recommended. These include:

- Clothes dryer
  - Range top
  - Stovetop fan
  - Central vacuum system
  - Bathroom exhaust fans unless they are specifically designed for this purpose
- These appliances may cause lint, dust or grease to collect in the ERV, damaging the unit.



Connecting any of these types of appliances to the ERV will void your warranty.

## Mounting- Chain mount

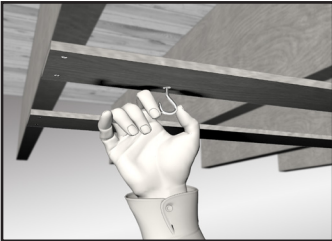

- 1** Place fastening hooks on the strapping board or the floor joists.

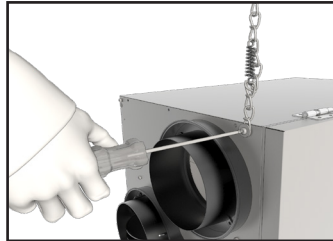

- 2** Attach a hanging chain (provided) to each 19 mm (3/4") bolt (provided) in the top 4 corners of the unit and tighten.

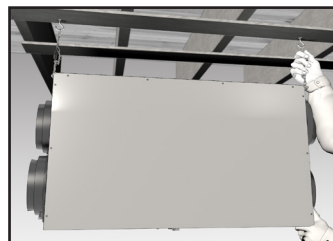

- 3** Hang the unit by slipping a link onto the hanging hooks, making sure the unit is level.



- 4** Install a spring on each chain. Hook the spring in the links so a loop is created in the chain. The spring will then support the unit's weight and absorb vibrations.

## INSTALLING DRAIN LINE

Through normal operation and during its defrost mode, the ERV may produce some condensation. This water should flow into a nearby drain, or be taken away by a condensate pump. The ERV and all condensate lines must be installed in a space where the temperature is maintained above the freezing point. A "P" trap should be made in the drain line. This will prevent odors from being drawn back up into the unit.



The drain nipple is placed upside down in the unit to prevent it being damaged during shipping or the installation of the unit.

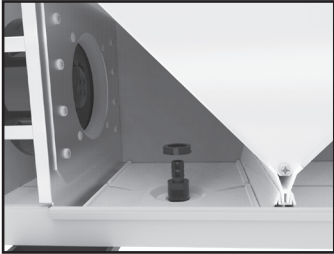

**1** Remove the nutsert.

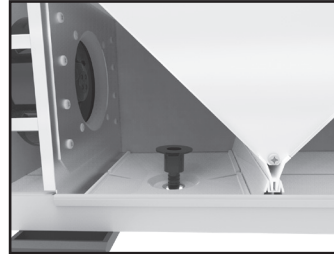

**2** Invert the drain nipple. Make sure to place gasket between the unit and the drain nipple inside the unit.

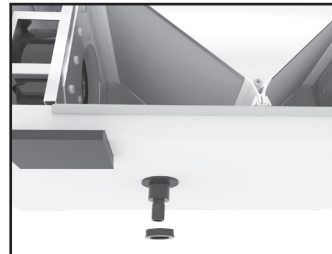

**3** Secure the drain nipple using the nutsert.

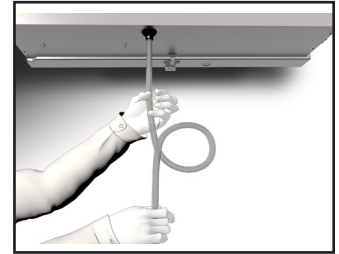

**4** Install the drain hose making a "P" trap, secure the condensate line drain connection using the tube clamp provided. Fill the condensate line with water.

## Start up procedure

The Switch on the side of the unit is used to toggle between STANDBY, REDUCED speed and NORMAL speed modes.

Place the unit in NORMAL speed to perform the balancing.

## Airflow balancing

### IF THE UNIT'S AIR FLOWS ARE NOT PROPERLY BALANCED...



- THE UNIT'S EFFICIENCY MAY BE REDUCED.
- THE UNIT'S CORE MAY BECOME DAMAGED.
- NORMAL OPERATION OF THE UNIT COULD CAUSE THE PRESSURIZATION OR DEPRESSURIZATION OF YOUR HOME, WHICH CAN LEAD TO AIR LEAKS OR BACKDRAFTING OF ANY COMBUSTION APPLIANCES.

The balancing procedure consists of measuring the supply air flow and the return air flow to ensure that they are equal. A difference of up to 10% is considered acceptable. In the cases where the air flow is not exactly the same, it is recommended to have a higher return air flow to ensure that the temperature of the supply air flow coming from outside is as close to room temperature as possible.



- For optimal performance, ERV unit should be re-balanced after a major renovation or after the installation of extra grilles or registers.

# Airflow balancing (Cont'd)

## Adjusting airflows



A damper is integrated into the Fresh Air to Building collar and on to the Stale Air to Outside. This damper replaces the installation of a separate damper into the Fresh Air to Building and on to the Stale Air to Outside ducting line.

The damper-collar is pre-set in the fully opened position. If the procedure requires a reduction in airflow to the fresh air duct, simply turn positioning knob located on the side of the collar clockwise until desired airflow is obtained. The damper position can be determined by the orientation of the pointers situated on the side of the damper. The damper is fully open when the pointers are towards the top of the collar (as shown in picture)

and fully closed when they are sideways.

Once procedure is completed, install a piece of tape over positioning knob to avoid any tampering by the home owner.



**WARNING! DO NOT TURN POSITIONING KNOB COUNTERCLOCKWISE WHEN DAMPERS ARE FULLY OPENED AS DAMAGE MAY OCCUR TO THE MECHANISM**

## Measuring the airflow using station (grid) method

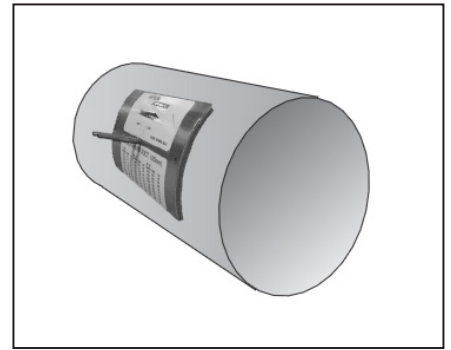
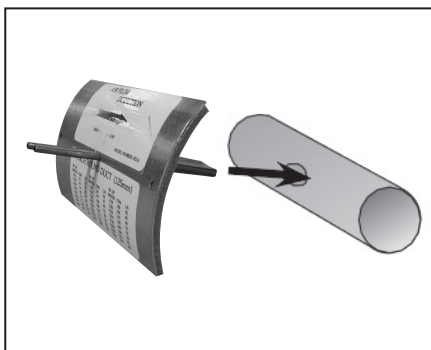

**1** Cut hole in duct and insert flow measuring station. Make sure that the flow measuring station's air direction arrow points in the direction of the airflow. Secure the flow measuring station with duct tape.

**2** Before taking the reading, make sure that the magnehelic gauge is level and at 0. Refer to the flow measuring station's chart to determine your unit's airflow velocity.

**3** Adjust the "Supply Air Out" damper until you reach the desired velocity. Follow steps 1-3 to adjust the "Exhaust Air Out" damper, if needed.

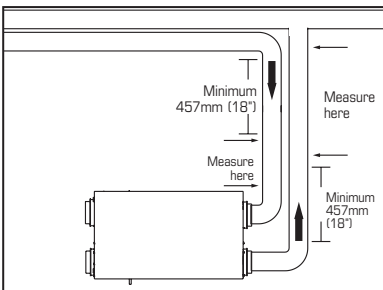

- To avoid airflow turbulence and incorrect readings, the airflow velocity should be measured on a section of steel ducting. Reading should also be taken at a minimum distance of 457 mm (18") from the unit or elbow. Measurement should also be made prior to any transition in the duct work so entire airflow is measured.





# Low Voltage Control Systems

\* Please see instruction manuals for individual controls for proper wiring and set up of control systems.

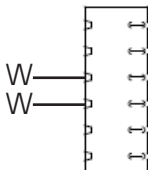

## CENTRAL CONTROLS

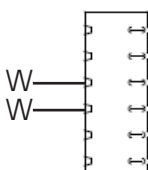
These control options can only be used individually

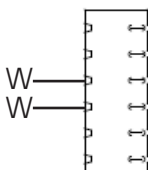
CONTROLS	FEATURES	CONNECT TO
<b>ECO-Touch®</b> 	<ul style="list-style-type: none"> <li>• Our most complete, yet easy to use control system</li> <li>• Sleek design with backlight touchscreen LCD</li> <li>• ECO mode selects the best operating mode and speed for the season, minimizing energy use associated with ventilation</li> <li>• Set preferred indoor relative humidity range and ventilation mode for day and night conditions</li> <li>• No battery to replace, all programmed settings are retained during power outage</li> <li>• Maintenance reminder indicator</li> <li>• Error code messages reduce troubleshooting time</li> </ul>	
<b>EDF7</b> 	<ul style="list-style-type: none"> <li>• MODE button provides 3 modes of operations: Ventilation , Recirculation and Standby</li> <li>• User selected fan speed: Reduced, Medium, Normal and 20 minutes per hour</li> <li>• AUTO setting allows the homeowner to deactivate the dehumidistat</li> <li>• When the humidity exceeds the desired setpoint, the ventilation system operates at Normal speed.</li> <li>• Once the desired humidity level is achieved, your ventilation system resumes to its previous mode of operation</li> </ul>	
<b>EDF1</b> 	<ul style="list-style-type: none"> <li>• Press button once for continuous Reduced speed</li> <li>• Press button twice and the unit will cycle 20 minutes ON/ 40 minutes OFF and repeat</li> <li>• Press button a third time and the system will run continuously on HIGH speed</li> </ul>	

1. Ensure that unit is not plugged when connecting the control
2. Recirculation mode is only available with the "R" suffix at the end of the model number.







The wiring connectors can be removed for easier connection.

\*Maintain polarity between control and ERV

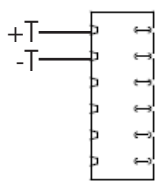
(+ → + ; - → -)

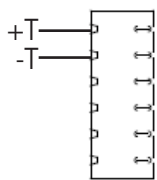
## AUXILIARY CONTROL – These controls can be paired

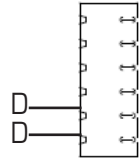
<b>RTS2*</b> 	<ul style="list-style-type: none"> <li>• 20- minute timer with LED light</li> <li>• Boosts system to high speed with the touch of a button</li> <li>• Up to 5 can be used in one system</li> <li>• Use in bathroom, kitchen, laundry room</li> </ul>	
<b>RTS5</b> 	<ul style="list-style-type: none"> <li>• 20/40/60 minute timer with LED light</li> <li>• Boosts system to high speed with the touch of a button</li> <li>• Up to 5 can be used in one system</li> <li>• Use in bathroom, kitchen, laundry room</li> </ul>	
<b>MDEH1</b> 	<ul style="list-style-type: none"> <li>• Rotary dial Dehumidistat</li> <li>• Multiple units can be used</li> <li>• We recommend setting the relative humidity above 80% during the summer</li> </ul>	

# WIRING DIAGRAM

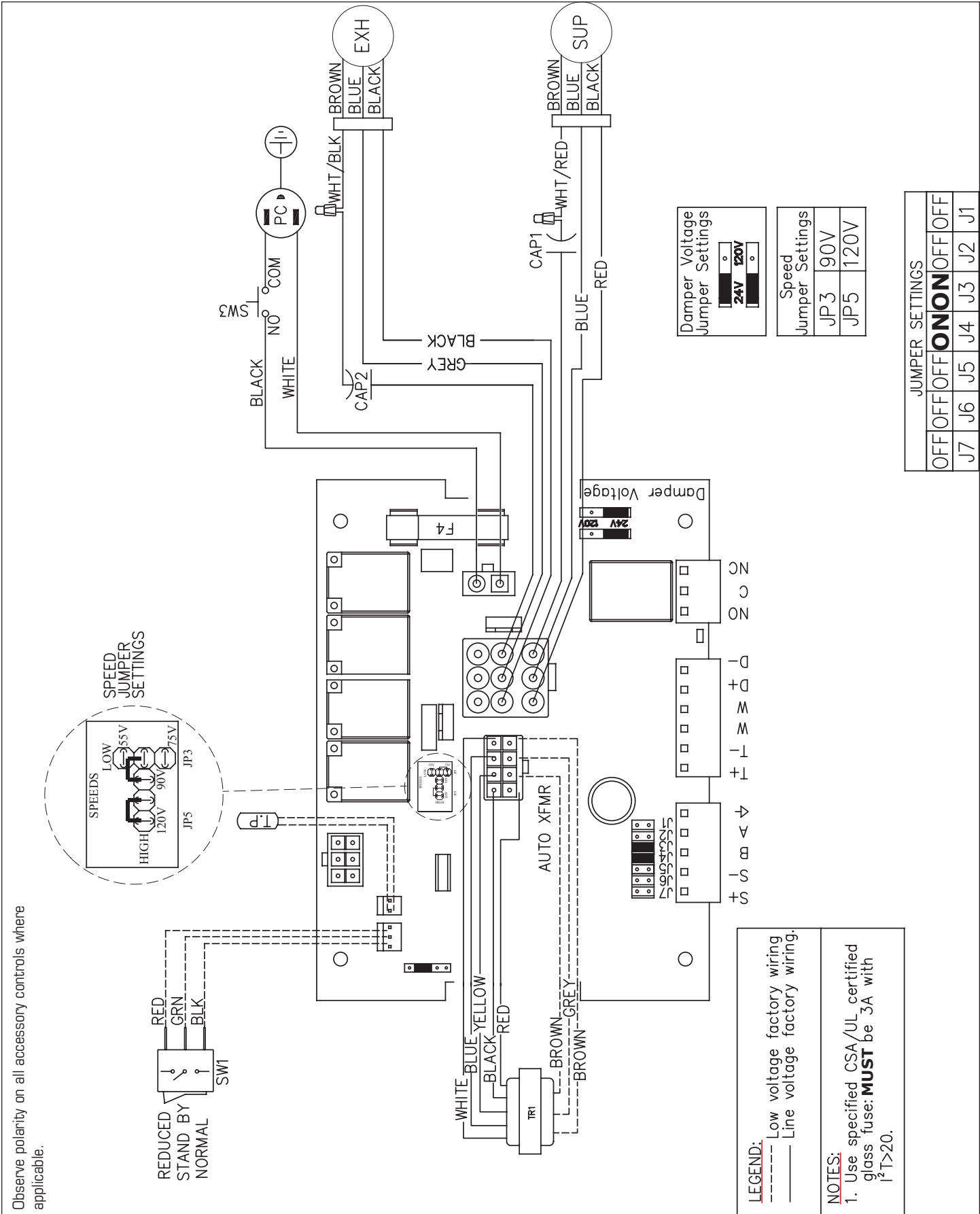

# WIRING DIAGRAM (CONT'D)

## WIRING DIAGRAM TO FURNACE



### FOR A FURNACE CONNECTION TO A COOLING SYSTEM:

On some newer furnaces and older thermostats, energizing the R and G terminal at the furnace has the effect of energizing the Y at the thermostat and thereby turning on the cooling system. If you identify this type of thermostat, you must use the "Alternate Furnace Interlock Wiring"

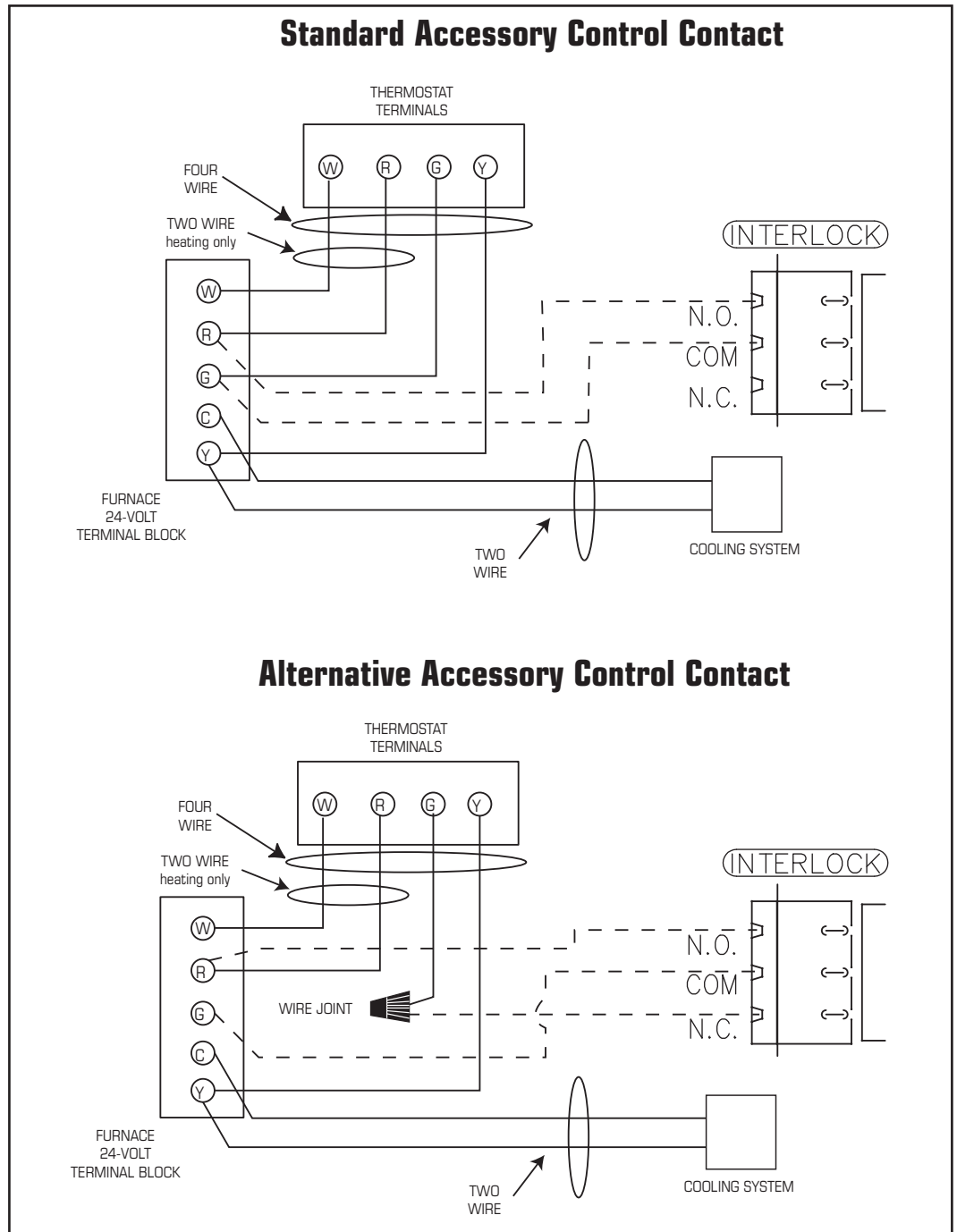

**As per building codes and installation requirements for combustion appliances:**  
**Air return ducts, or openings for air return, should not be placed in enclosed spaces containing combustion appliances that are subject to spillage.**

# TROUBLESHOOTING

Problem	Causes	Solutions
Air is too dry	Dehumidistat control is set too low	Increase the desired level of humidity. Change ventilation mode from continuous mode to standby.
	ERV out of balance	Have contractor balance ERV airflows
Air is too humid	Dehumidistat control is set too high	Reduce the desired level of humidity. Combine this with the use of continuous exchange mode.
	Sudden change in temperature	Wait until outside temperature stabilizes (winter). Heating will also improve situation.
	Storing too much wood for heating	Store a majority of your wood outside. Even dried, a cord of wood contains more than 20 gallons of water.
	Dryer vent exhaust is inside home	Make sure the dryer vent is exhausting outside.
	Poor air circulation near windows	Open curtains or blinds.
	ERV out of balance	Have contractor balance ERV airflows
	Well sealed basement door is closed	Open the door or install a grill on the door.
	Failed damper system may be stuck in recirculation mode	Check defrost damper. If damper is always blocking incoming fresh air, have contractor verify damper system.
Persistent condensation on window	Improper adjustment of dehumidistat control	Reduce the desired level of humidity. Combine this step with use of continuous exchange mode.
	ERV out of balance	Have contractor balance ERV
	Poor air circulation near windows	Open curtains or blinds.
Poor Air Flows	1/4" (6mm) mesh on the outside hoods is plugged	Clean exterior hoods or vents
	Filters plugged	Remove and clean filter
	Core obstructed	Remove and clean core
	Indoor grilles closed or blocked	Check and open grilles
	Inadequate power supply at site	Have electrician check supply voltage
	Ductwork is restricting airflow	Check duct installation
	Improper speed control setting	Increase the speed of the ERV (i.e. change unit control from REDUCED to NORMAL speed)
	ERV airflow improperly balanced	Have contractor balance ERV airflows
	Ducting has fallen down or been disconnected from ERV	Have contractor reconnect ducting
Supply air feels cold	Poor location of supply grilles, the airflow may irritate the occupant	Locate the grilles high on the walls or under the baseboards, install ceiling mounted diffuser or grilles so as not to directly spill the supply air on the occupant (eg. Over a sofa) Turn down the ERV supply speed. A small duct heater (1kw) could be used to temper the supply air Placement of furniture or closed doors is restricting the movement of air in the home
	Outdoor temperature extremely cold	If supply air is ducted into furnace return, the furnace fan may need to run continuously to distribute ventilation air comfortably
ERV and/or Ducts frosting up	ERV air flows are improperly balanced	Have HVAC contractor balance the ERV airflows
	Malfunction of the ERV defrost system	Note: minimal frost build-up is expected on the core before unit initiates defrost cycle functions
Condensation or Ice Build Up in Insulated Duct to the Outside	Incomplete vapor barrier around insulated duct	Tape and seal all joints
	A hole or tear in outer duct covering	Tape any holes or tears made in the outer duct covering Ensure that the vapor barrier is completely sealed.
LED is flashing	Everything is in good operations	
LED is not flashing	No Power is being transmitted to the Control Board	Make sure unit is plugged. Transformer may need replacing.

**Note:** It is best to get the unit checked by a certified HVAC Contractor/Technician.



# ERV MAINTENANCE CHART

Maintenance Required	Recommended Frequency	Date Maintenance Performed					
Check and Clean Filters	Every 3 months or if dirty						
Check Energy Recovery Core	Every 6 months						
Check Drain Pan and Lines	Every 3 months						
Vacuum the Inside of the Unit	Annually						
Clean and Un-block Outside Hoods	Annually						
Clean and Inspect Duct Work	Annually						
General Servicing by a Qualified Contractor	Annually						

\* Schedule may be altered to meet your own needs. More frequent servicing may be required depending on the severity of your home's indoor and outdoor environments.

Contractor	Telephone Number	Date Serviced

## Limited Warranty

- The Energy recovery core has limited 5 year warranty.
- The warranty is limited to 5 years on parts and 7 years on fans from the date of purchase, including parts replaced during this time period. If there is no proof of purchase available, the date associated with the serial number will be used for the beginning of the warranty period.
- The fans found in all Fantech ERVs require no lubrication, and are factory balanced to prevent vibration and promote silent operation.
- The limited warranty covers normal use. It does not apply to any defects, malfunctions or failures as a result of improper installation, abuse, mishandling, misapplication, fortuitous occurrence or any other circumstances outside Fantech's control.
- Inappropriate installation or maintenance may result in the cancellation of the warranty.
- Any unauthorized work will result in the cancellation of the warranty.
- Fantech is not responsible for any incidental or consequential damages incurred in the use of the ventilation system.
- Fantech is not responsible for providing an authorized service centre near the purchaser or in the general area.
- Fantech reserves the right to supply refurbished parts as replacements.
- Transportation, removal and installation fees are the responsibility of the purchaser.
- The purchaser is responsible to adhering to all codes in effect in his area.

\* This warranty is the exclusive and only warranty in effect relative to the ventilation system and all other warranties either expressed or implied are invalid.

# ERV core washing instructions

For proper maintenance of your energy recovery core please follow these instructions



**1** Remove both filters by sliding them out.

**2** Remove the core from the unit.

**3** With one of your core's air inlets facing down, place it in a large sink, bathtub, or shower.

**4** Pour clean tap water through the face of the core facing upwards until it runs clear. Ensure the entire surface is rinsed.

**5** Rotate the core so that its other air inlet is facing down and repeat step 5.

**6** With plates still oriented vertically allow the core to dry, normally 2-3 hours.

**7** Slide back the core into the unit

**8** Replace both filters.

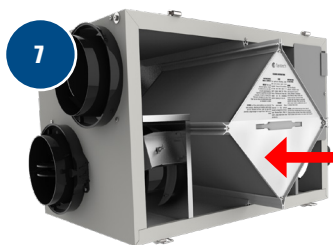

# PARTS LIST

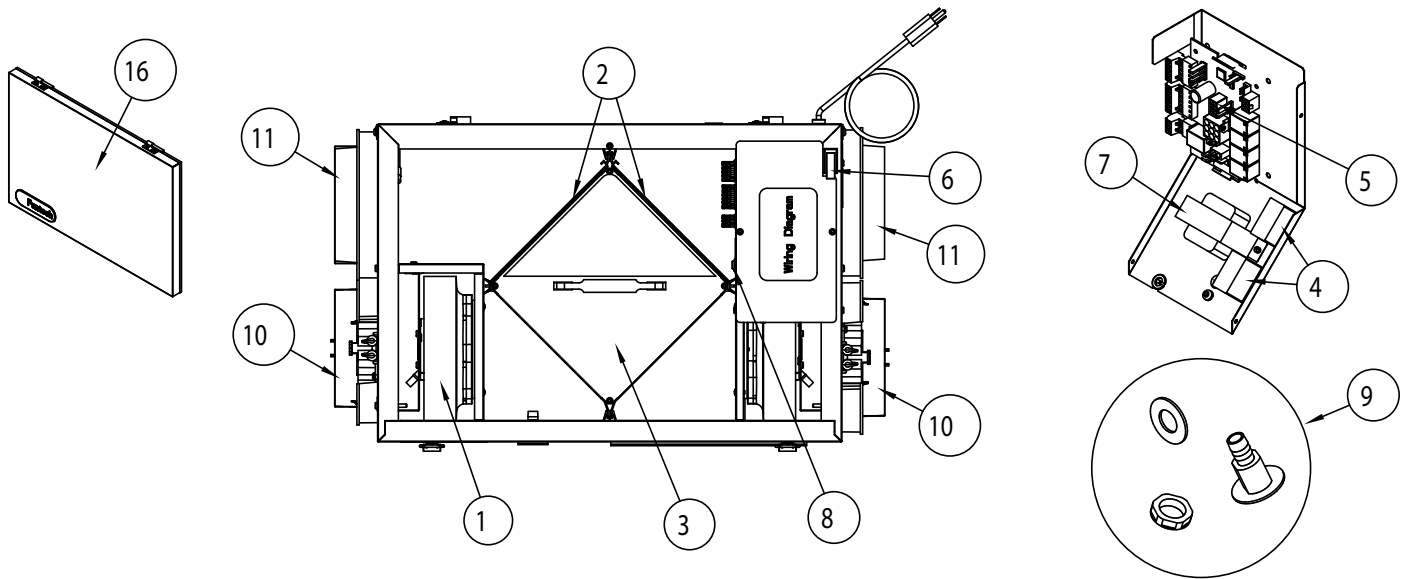

BOM #	Description	SER200 (99226)
1	Kit, Repl, Motor, R2E220	40323
2	Filter, 2x R-200 (11.5 x 15) Rep. Kit	40327
3	Energy Recovery Cell 12" x 12" x 15"	427789
4	Capacitors 10uF	410040
5	Kit,PCB Replacement,Board,AC	422677
6	Door Switch	410867
7	Auto-Transformer	411963
8	Control Switch	410213
9	Kit Drain Plug	40315
10	Collar, 6", Balancing, 10mm	412284
11	Collar 6", 24mm, LIP	410542
15	Temperature Probe	40286
16	Door Assembly	427756
	Kit, Chain	404261
	Wall Support,VHR200	422998
	Filter,MERV-6,11.5x15x0.125"	412630
	Wiring Diagram	422576
	Installation Manual	427787

Fantech reserves the right to make technical changes.  
For updated documentation please refer to [www.fantech.net](http://www.fantech.net)

Fantech®