

8" x 14" Foundation Vent Model # FV2021-FB

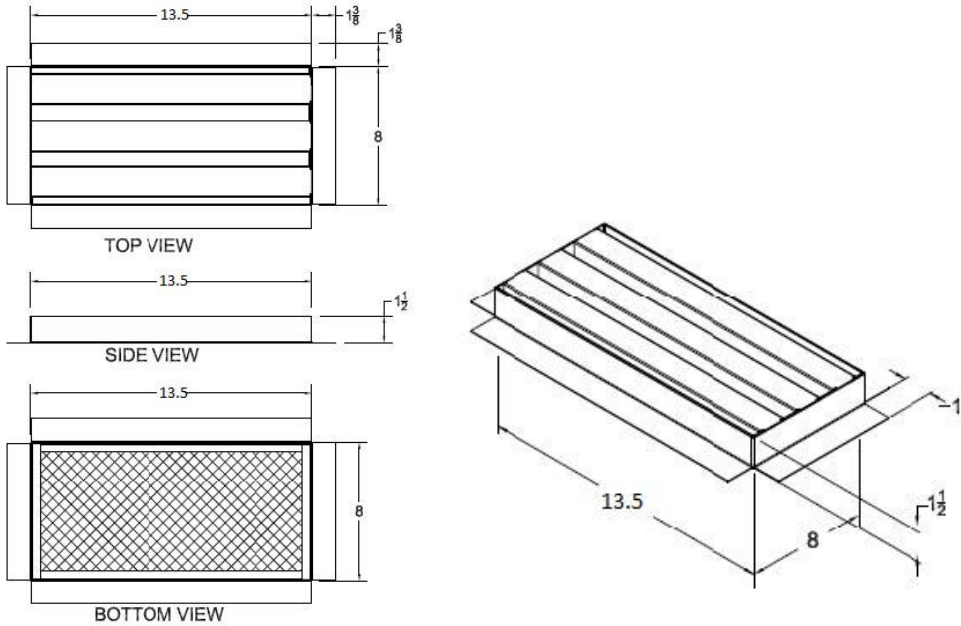

Foundation Vents	Model	Size W x L	NFVA Provided (Sq In)	Flanges Available	Flange Definition	Weight
	FV2021-FB	8" x 14"	34	Flange Back	Flange Back	3.5 lbs
Custom sizes/shapes/materials AVAILABLE						

BENEFITS:

- Safety vents that are used in areas prone to wildfires, wind driven rain, or wind driven snow.
- **Triple Protection (Patented)**
 - **Overlapping baffles** resist embers, flames and radiant heat
 - Heat activated **Intumescent Strips** expand & seal openings during extreme fire conditions
 - **1/16" mesh** on back side of vent for additional ember and bug protection
- WUI Approved for use throughout California and beyond ([Calfire BML Approval # 8165-2232:0502](#))
- Tested and Listed to ASTM E2886/2912
- 1 hour Fire Rated per ASTM E119
- Air Flows through normally
- Also Prevents Rodent Entry
- Easy to Install, Retrofit and Paint

STANDARD MATERIALS

ASTM A653/A653M- G90 hot dipped galvanized steel, 26GA
 ASTM D9092- mill phosphatized coating for painting. IF BONDERIZED
 ASTM b370- Sheet Copper, 16oz and 20oz IF GALVANIZED
 .0625 x.0625 hot dipped galvanized 23ga wire mesh

Installation:

Install like any other similar Ventilator Product on the market.