

Installation Manual

BFRK100

Bath Fan Retrofit Kit

PARTS IN THE BOX

Inline Fan FG4, 1 pc
Mounting Bracket, 1 pc
VT 20M Main Control, 1 pc
3" to 4" Adapters, 2 pcs
Wire Connectors, 2 pcs
Cable Restaint, 1 pc
8' Flexible Insulated 4" Duct, 1 pc
12' 14-2 Insulated Electrical Wire, 1 pc
Operation and Installation Manual, 1 pc



REGISTER* THIS PRODUCT TO
INCREASE YOUR PRODUCT
WARRANTY BY AN EXTRA YEAR

registration.fantech.app

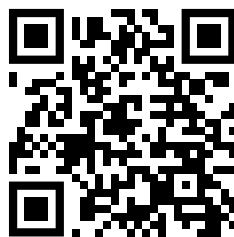

* in USA only





Technical / Customer Support:

United States Tel.: 800.747.1762

Canada Tel.: 800.565.3548

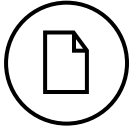

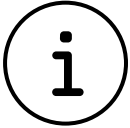
fantech[®]
a systemair company

				
Note	Warning / Important note	Information	Technical information	Practical tip



Read and Save these instructions for future reference.

Not for use with fan/light, heater/fan, or heater/fan/light combination units

Warnings

DO NOT CONNECT POWER SUPPLY until fan is completely installed. Make sure electrical service to the fan is locked in "Off" position

1. All units are suitable for use with solid-state speed control.
2. This unit has rotating parts and safety precautions should be exercised during installation, operation and maintenance.
3. **CAUTION:** "For General Ventilation Use Only. Do Not Use To Exhaust Hazardous Or Explosive Materials And Vapors."
4. **WARNING:** To reduce the risk of fire, electrical shock, or injury to persons-observe the following:
 - a. Use this unit only in the manner intended by the manufacturer. If you have questions, contact the factory.
 - b. Before servicing or cleaning, switch power off at service panel and lock service panel to prevent fan from being switched on accidentally.
 - c. Installation work and electrical wiring must be done by qualified person(s) in accordance with all applicable codes and standards, including fire-rated construction.
 - d. The combustion airflow needed for safe operation of fuel burning equipment may be affected by this unit's operation. Follow the heating equipment manufacturer's guidelines and safety standards such as those published by the National Fire Protection Association (NFPA), the American Society of Heating, Refrigeration, and Air Conditioning Engineers (ASHRAE) and the local code authorities.
 - e. When cutting or drilling into wall or ceiling, do not damage electrical wires or other hidden utilities.
 - f. Exhaust fans must always be vented to the outdoors.
 - g. Acceptable for use over a bathtub or shower.
 - h. NEVER place a switch where it can be reached from a tub or shower.
5. **WARNING!** Check voltage at the fan to see if it corresponds to the motor nameplate.

GUARDS MUST BE INSTALLED WHEN FAN IS WITHIN REACH OF PERSONNEL OR WITHIN SEVEN (7) FEET OF WORKING LEVEL OR WHEN DEEMED ADVISABLE FOR SAFETY.

Installation

Step 1

Switch power off at service panel and lock the service disconnecting means to prevent power from being switched on accidentally.

Step 2

In the bathroom, remove the inlet grille.

Step 3

Unplug the motor and remove the motor plate. If convenient, you may want to remove the motor from the motor plate at this stage.



The motor from your existing fan will not be used when your retrofit installation is complete. However, the motor plate may be essential for attaching the inlet grille.

Step 4

Remove the wiring cover of your existing ceiling mounted bath fan. Disconnect the power wires to your existing fan.

Step 5

Attach the flexible duct provided to the inlet port of the new fan. Tape the black inner liner to the four inch diameter lip and tape the reflective outer shell to the larger diameter shoulder. Do not leave the insulation material exposed.

Step 6

Electrical Connection for new fan

- A Remove the screws securing the terminal box cover located on the side of the fan. All fan motor connections are pre-wired to an electrical terminal strip. Use the cable restraint provided to secure the wiring through the hole on the electrical box.
- B Be sure to place the connector nut over the wiring coming into the electrical box. There are two open ports on the terminal strip. Using a small regular screwdriver, tighten the neutral (white) wire of the incoming supply under the open terminal strip port labeled "N". Tighten the line (black) wire of the incoming supply under the open terminal strip port labeled "L". Tighten the ground (green) wire of the incoming supply under the open terminal strip port labeled with the Ground symbol. If the terminal strip is not labeled, follow the wiring diagram found on the inside of the electrical cover.
- C Secure the cable restraint. Secure the incoming supply with the cable restraint. Replace the fan electrical box cover. All fan motor and capacitor connections have been pre-wired from the factory. No additional fan wiring is necessary.
- D The other end of the electrical cable will be connected in a later step.

Step 7

In the attic or crawl space, find the location of the existing bath fan and its exhaust duct. Select a location for the new FG 4 fan. The new fan will be connected to part of the existing exhaust duct so you must plan to locate the new fan along the line of the existing exhaust duct, no greater than seven feet from the existing fan. Fan location should allow sufficient access for service. For applications that require the new FG4 fan to be located more than seven feet from the existing fan, longer lengths of electrical cable and flexible insulated 4" duct can be purchased separately.



Step 3

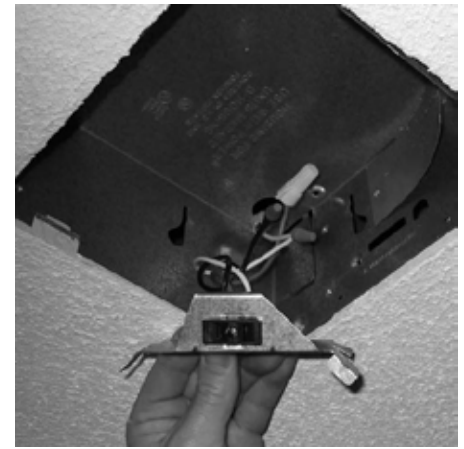

Step 4

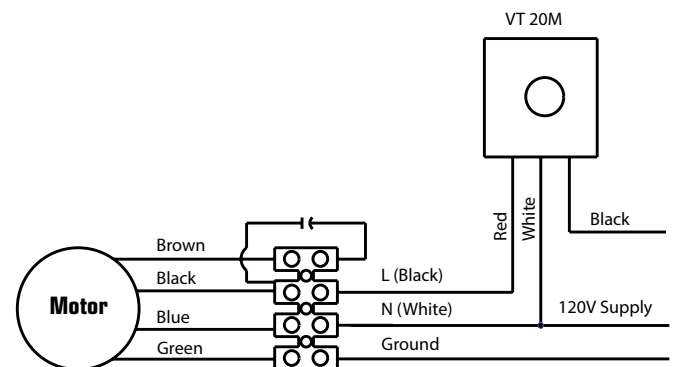

Installation (Cont'd)

Step 8

Using the wood screws provided, attach the mounting bracket to a support beam at the selected location. Fan mounting can be at any point along the duct and in any angle, however, vertical mounting is recommended to reduce condensation buildup in the fan. If a horizontal installation is necessary and condensation buildup may pose a problem, either wrap insulation around the fan or drill a 1/4" hole in the bottom of the housing (along with an NPT insert [by others] and drain tubing) allowing condensation to drain.

Step 9

Cut the existing duct 8" above the mounting bracket. Make a second cut in the duct at approximately 12" from the existing fan, and then remove this middle section of the existing duct.

Step 10

Attach fan to the mounting bracket with the sheet metal screws provided. Wiring box should be positioned for easy access. Screws are self tapping and do not require pilot holes. However, pilot holes (no larger than 3/32") are recommended.

Step 11

Connect the section of the existing duct (from the roof cap, wall cap or soffit vent) to the outlet port of the new fan using duct tape. If your existing exhaust duct is 3" diameter, use one of the 3" to 4" adapters (supplied in the kit). (Seal ducts adhering to local and national codes.)

Step 12

Connect the section of the existing duct (from the discharge of the existing fan) to flexible duct (from the inlet on the new fan) using duct tape. If your existing exhaust duct is 3" diameter, use one of the 3" to 4" adapters (supplied in the kit). Tape the black inner liner to the four inch diameter lip and tape the reflective outer shell over the top of the inner liner. Do not leave the insulation material exposed.

Step 13

Uncoil the new electrical cable from the new fan. Loosen the cable restraint on the existing fan and feed 4" of the new cable through the restraint, next to the existing electrical cable. Tighten the screws on the cable restraint of the existing fan.

Step 14

In the bathroom, connect the new cable to the existing power supply (black wire to black wire, white wire to white wire) using the wire nuts provided.

Step 15

Carefully push the new connections back into the fan housing (or wiring box within the fan housing) making sure that no wires will be pinched before putting the wiring cover and motor plate back into position. Reattach the fan grille.

Step 16

Install the VT20M fan controller in an electrical box upstream of the fan. See also the instructions included with the VT20M controller.

Step 17

Restore electrical service, switch on and verify airflow

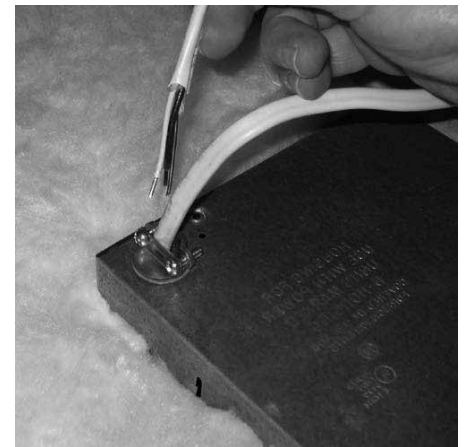
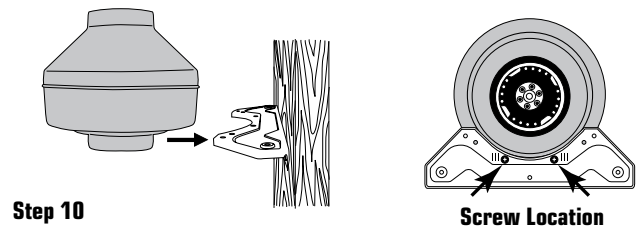

Warranty

Five (5) Year Warranty

This warranty supersedes all prior warranties

DURING ENTIRE WARRANTY PERIOD:

Fantech will repair or replace any part which has a factory defect in workmanship or material. Product may need to be returned to the Fantech factory, together with a copy of the bill of sale and identified with RMA number.

FOR FACTORY RETURN YOU MUST:

- Have a Return Materials Authorization (RMA) number. This may be obtained by calling Fantech either in the USA at 1.800.747.1762 or in CANADA at 1.800.565.3548. Please have bill of sale available.
- The RMA number must be clearly written on the outside of the carton, or the carton will be refused.
- All parts and/or product will be repaired/replaced and shipped back to buyer; no credit will be issued.

OR

The Distributor may place an order for the warranty part and/or product and is invoiced. The Distributor will receive a credit equal to the invoice only after product is returned prepaid and verified to be defective.

FANTECH WARRANTY TERMS DO NOT PROVIDE FOR REPLACEMENT WITHOUT CHARGE PRIOR TO INSPECTION FOR A DEFECT. REPLACEMENTS ISSUED IN ADVANCE OF DEFECT INSPECTION ARE INVOICED, AND CREDIT IS PENDING INSPECTION OF RETURNED MATERIAL. DEFECTIVE MATERIAL RETURNED BY END USERS SHOULD NOT BE REPLACED BY THE DISTRIBUTOR WITHOUT CHARGE TO THE

Limitation of Warranty and Liability

This warranty does not apply to any Fantech product or part which has failed as a result of faulty installation or abuse, incorrect electrical connections or alterations made by others, or use under abnormal operating conditions or misapplication of the product or parts. We will not approve for payment any repair not made by us or our authorized agent without prior written consent. The foregoing shall constitute our sole and exclusive warranty and our sole exclusive liability, and is in lieu of any other warranties, whether written, oral, implied or statutory. There are no warranties which extend beyond the description on the page hereof. In no event, whether as a result of breach of contract, or

Warning

Fantech products are designed and manufactured to provide reliable performance, but they are not guaranteed to be 100% free from defects. Even reliable products will experience occasional failures and this possibility should be recognized by the user. If these products are

used in a life support ventilation system where failure could result in loss or injury, the user should provide adequate backup ventilation, supplementary natural ventilation, failure alarm system, or acknowledge willingness to accept the risk of such loss or injury.

END USER, AS CREDIT TO DISTRIBUTOR'S ACCOUNT WILL BE PENDING INSPECTION AND VERIFICATION OF ACTUAL DEFECT BY FANTECH.

THE FOLLOWING WARRANTIES DO NOT APPLY:

- Damages from shipping, either concealed or visible. Claim must be filed with freight company.
- Damages resulting from improper wiring or installation.
- Damages or failure caused by acts of God, or resulting from improper consumer procedures, such as:
 1. Improper maintenance
 2. Misuse, abuse, abnormal use, or accident, and
 3. Incorrect electrical voltage or current.
- Removal or any alteration made on the Fantech label control number or date of manufacture.
- Any other warranty, expressed, implied or written, and to any consequential or incidental damages, loss or property, revenues, or profit, or costs of removal, installation or reinstallation, for any breach of warranty.

WARRANTY VALIDATION

- The user must keep a copy of the bill of sale to verify purchase date.
- These warranties give you specific legal rights, and are subject to an applicable consumer protection legislation. You may have additional rights which vary from state to state.

warranty or alleged negligence, defect incorrect advice or other causes, shall Fantech be liable for special or consequential damages, including, but not limited to, loss of profits or revenue, loss of use of equipment or any other associated equipment, cost of capital, cost of substitute equipment, facilities or services, downtime costs, or claims of customers of purchase for such damages. Fantech neither assumes or authorizes any person to assume for it any other liability in connection with the sale of product(s) or part(s). Some jurisdictions do not allow the exclusion or limitation of incidental or consequential damages so the above limitations and exclusions may not apply to you.

used in a life support ventilation system where failure could result in loss or injury, the user should provide adequate backup ventilation, supplementary natural ventilation, failure alarm system, or acknowledge willingness to accept the risk of such loss or injury.

Notes

Notes

Fantech reserves the right to make technical changes.
For updated documentation please refer to www.fantech.net

Fantech®